

JUNE, 1933

Radio Engineering

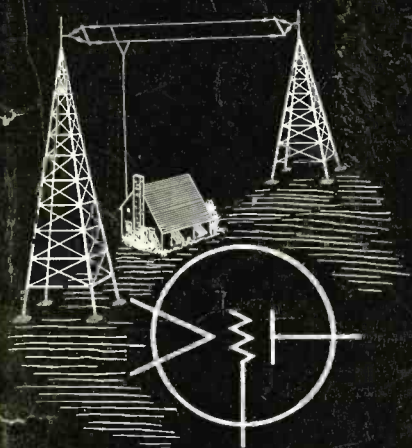

IN THIS ISSUE



PARTS AND ACCESSORIES FOR RADIO RECEIVERS

THE CATKIN TUBE

A STUDY OF HUM GENERATION IN VACUUM TUBES

By J. J. Glauber and A. G. Campbell

THE PROCESSING OF THORIATED TUNGSTEN FILAMENTS

By Milton A. Ausman

RADIO DISTRIBUTION SYSTEM FOR APARTMENT BUILDINGS

By C. F. Boeck

VOL. XIII, NO. 6

JUNE, 1933

The Journal of the
Radio and Allied Industries

SVEA METAL

--- for *QUALITY TUBES*

**A NEW PRODUCT
OFFERED TO
Progressive Tube
Engineers**

as the solution
of their problems
of
**QUALITY
and
COST**

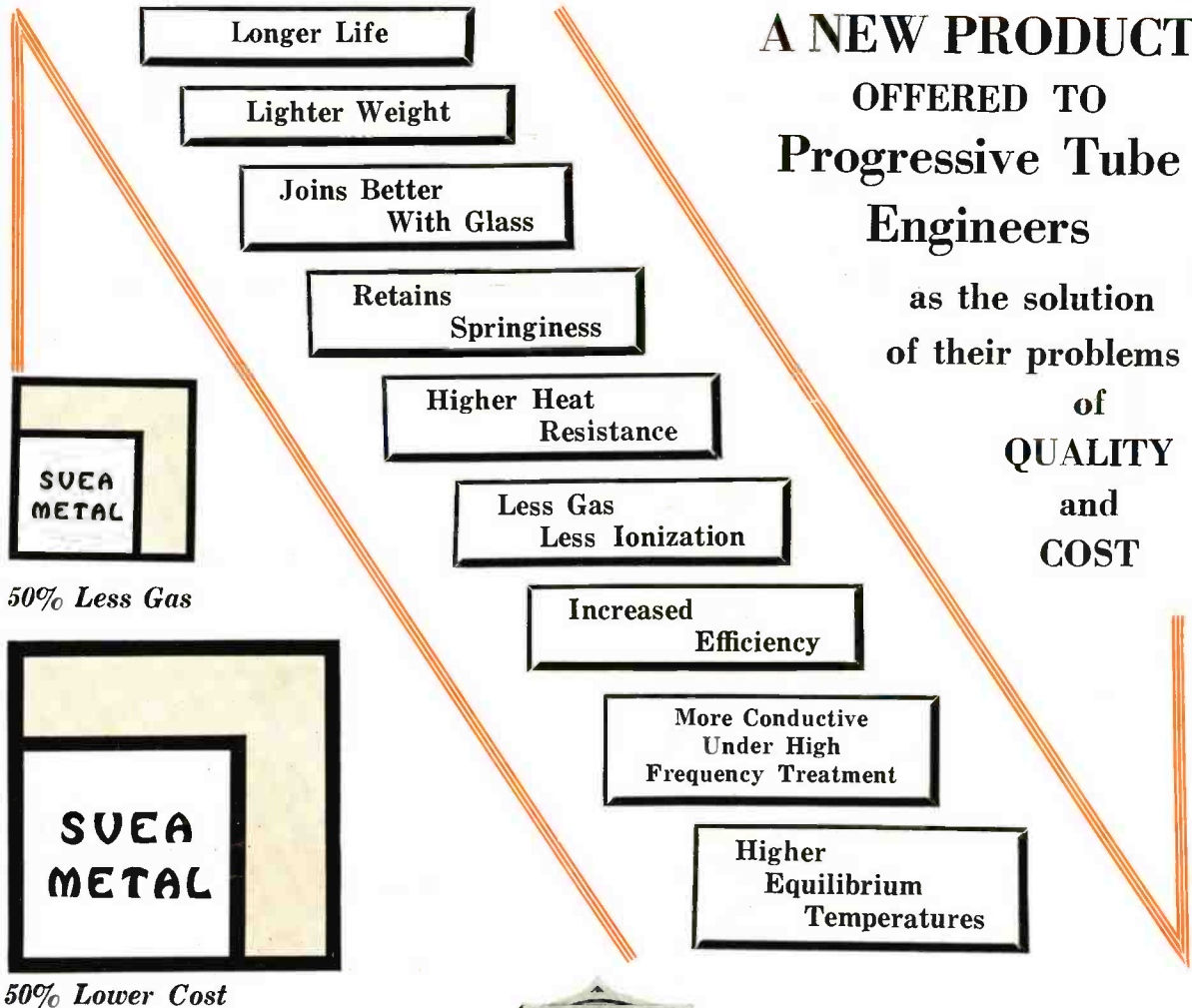

Swedish Iron &

17 Battery Place



Steel Corporation

New York City

For more than a quarter of a century suppliers of high grade metals to the foremost electrical equipment manufacturers.

Announcing **IMPORTANT
NEW DEVELOPMENTS IN**

IRC
Metallized
RESISTORS



Not since IRC introduced the Type "K" Metallized Filament two years ago have there been resistor refinements of the importance of those now announced by IRC engineers. These spell new and unusual records of performance in such essential resistor factors as permanence, overload and humidity characteristics, voltage coefficient and low level of noise. They are detailed and actual tests charted in a new booklet which we will gladly send to radio manufacturing executives who realize the necessity for keeping their products fully abreast of rapidly changing times.

A BOOKLET FOR
EVERY RADIO
ENGINEER. . . .
SEND FOR YOUR
COPY TODAY . .



**MOTOR
RADIO SUPPRESSORS**



"MS" SPARK PLUG SUPPRESSOR



"MD" DISTRIBUTOR SUPPRESSOR



NEW—"MCA" IMPROVED CABLE
END TYPE SUPPRESSOR

The same new low resistance contact which has resulted in outstanding refinements in IRC Metallized Resistors has proved equally important in its application to IRC Motor Radio Suppressors. It means definite elimination of the most common cause of suppressor failure—poor contact—and improvement in general suppression performance as well. Other IRC Suppressor features include solid, vibration-proof construction without springs, rivets, steel wool or other intermediate elements. Special treatments proof them against moisture, humidity and heat while extremely low capacity insures an absolute minimum of noise.

*Scientifically Designed for Lasting Service
On the Toughest Noise Suppression Job*

INTERNATIONAL RESISTANCE COMPANY

2100 ARCH ST.,

PHILADELPHIA, PA.

In Canada, 74 Wellington St. W., Toronto, Ontario

MAKERS OF METALLIZED, POWER AND PRECISION WIRE
WOUND RESISTORS AND IRC MOTOR RADIO SUPPRESSORS

RADIO ENGINEERING

Reg. U. S. Patent Office



Western Editor
ULMER G. TURNER

Editor
DONALD McNICOL

Managing Editor
F. WALEN

Vol. XIII

JUNE, 1933

Number 6

Contents

	PAGE
EDITORIAL	4
RMA PREPARES TO OPERATE UNDER "INDUSTRY CONTROL" PLAN	7
PARTS AND ACCESSORIES FOR RADIO RECEIVERS.....	8
AUTOMATIC REGENERATION..... <i>By R. W. Tanner</i>	10
THE CATKIN TUBE.....	11
A STUDY OF HUM GENERATION IN VACUUM TUBES <i>By J. J. Glauber and A. G. Campbell</i>	12
THE PROCESSING OF THORIATED TUNGSTEN FILAMENTS <i>By Milton A. Ausman</i>	15
ENGINEERING ORGANIZATION..... <i>By Richard F. Shea</i>	18
RADIO DISTRIBUTION SYSTEM FOR APARTMENT BUILDINGS <i>By C. F. Boeck</i>	20
A CHRONOLOGICAL HISTORY OF ELECTRICAL COMMUNICATION —TELEGRAPH, TELEPHONE AND RADIO, PART XVIII....	22

Departments

NEWS OF THE INDUSTRY.....	24
NEW DEVELOPMENTS OF THE MONTH.....	26
INDEX OF ADVERTISERS.....	30

A SALESMAN'S EFFICIENCY CHECK LIST

A RECENT issue of the news-letter of the Associated Coffee Industries of America contains this salesman's check list under the heading, "Why I Lost That Order":

1. I lost the order because I was afraid the buyer would say "No."
2. I called without knowing anything about the prospect's business or needs.
3. I lost the order to a firm whose price was lower, because I didn't have enough facts to prove my product was worth the money.
4. I had neglected my prospect too long—a competitive salesman beat me to it because he was there asking for the order.
5. I let myself get into an argument with the buyer—which I won. That is why I lost the sale.
6. I too willingly accepted the buyer's objections.

BRYAN S. DAVIS
President

JAS. A. WALKER
Secretary

Published Monthly by

Bryan Davis Publishing Co., Inc.

**19 East 47th Street
New York City**

SANFORD R. COWAN
Advertising Manager

J. E. NIELSEN
Circulation Manager

Chicago Office—1221 Rosemont Ave.—Charles H. Farrell, Mgr.
St. Louis Office—505 Star Building—F. J. Wright
Kansas City, Mo. Office—306 Coca Cola Building—R. W. Mitchell
Cleveland Office—Millard H. Newton, 316 National Bldg.
Boston, Mass., Office—Lawrence Mitchell—80 Boylston St.



San Francisco Office—155 Sansome St.—R. J. Birch
Los Angeles Office—846 S. Broadway—R. J. Birch
Philadelphia Office—1513 N. 13th St.—H. S. Thoenes
New Zealand—Tearo Book Depot—Wellington.
Melbourne, Australia—McGill's Agency.

Entered as second class matter August 26, 1931, at the Post Office at New York, N. Y., under Act of March 3, 1879. Yearly subscription rate \$2.00 in United States. \$3.00 in Canada and foreign countries.

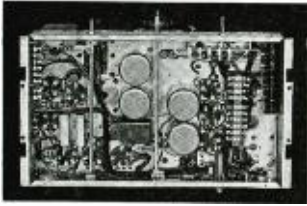

Where fastenings are made in hard-to-get-at places

Self-tapping Screws cut time and cost in half

In making hard-to-get-at fastenings these unique Screws have no equal. Driven like a wood screw... forming a thread in the metal as they are turned into a plain hole... Parker-Kalon Hardened Self-tapping Sheet Metal Screws offer the only real speedy, simple, cheap way of making sheet metal assemblies in cramped places.

It saves time... costs much less to use these famous Screws instead of common devices. You avoid the fumbling and poor fastenings that go with riveting and bolts and nuts. You eliminate the tapping operations, tap plates, stripped and crossed threads and difficult starting involved in the use of machine screws.

Practically all radio manufacturers have gained lower assembly costs by using Parker-Kalon Hardened Self-tapping Sheet Metal Screws for attaching parts to chassis. Among them are — Atwater-Kent, Crosley, Philco, R.C.A.-Victor, Stewart-Warner, Spartan, Stromberg-Carlson, Wurlitzer.



Stronger Fastenings, too

Under stresses of tension, shear and vibration Self-tapping Screws hold better than the ordinary devices— machine screws and bolts and nuts. It's easy to see why when you look at the microphotographs here. The obviously tighter engagement of a Self-tapping Screw means greater security.

Try Self-tapping Screws, Free

Find out for yourself how much easier, quicker and cheaper it is to make fastenings with these Screws. Use the coupon to get a FREE

"Money-Saver Test Bag" of samples with our unbiased recommendations.

Where and How to use them

Parker-Kalon Hardened Self-tapping Screws For making fastenings to sheet metal up to 6 ga., aluminum, die castings, Bakelite, etc. Turn Screw into drilled, pierced or molded hole. It forms a thread in the material as it turns in. Can be removed and replaced. Available in a full range of diameters and lengths, and 5 styles of heads as shown below.

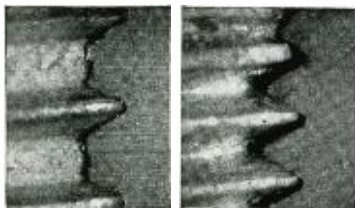

See tight engagement of Self-tapping Screw. Note loose fit of machine screw in tapped hole.

PARKER-KALON *Hardened* Self-tapping Screws

PAT. IN U. S. AND FOREIGN COUNTRIES

PARKER-KALON CORPORATION, DEPT. L, 190-198 VARICK STREET, NEW YORK, N. Y.

Tell me whether assemblies described on attached sheet can be made cheaper with Self-tapping Screws. I'll make a "Money-Saver Test" if you send samples and recommendations—Free.

Name and Title.....
 Company.....
 Address.....



E d i t o r i a l

JUNE, 1933

QUALITY OF AUDIO OUTPUT

QUALITY of sound reproduction as a function of loudspeakers is a subject which has had continuous consideration during the past few years. Of the types of distortion which may affect quality, frequency distortion, phase distortion and amplitude distortion have come to be recognized as analyzable factors.

The first results from the non-uniform frequency-response characteristic of the system; the second, from certain frequency components being displaced in their relations with other components, and the last named, from non-linear amplifying characteristics within the system.

Obviously the effect of phase distortion is not serious, but with respect to amplitude distortion it is experience that overloaded amplifiers sometimes introduce sufficient harmonic content to make the quality of audio output poor.

In the I. R. E. Proceedings for May, 1933, Frank Massa has a paper which reports results of an inquiry made to determine how much overloading may be allowed in an amplifier without materially affecting the quality. From the data submitted it is apparent that the presence of amplitude distortion becomes more evident as the frequency range of the reproducing system is increased.

GOVERNMENT GUIDANCE OF INDUSTRY

WITH the implied alternative of actual Government participation in private industry the President's industrial recovery bill contains elements of challenge to American business executives.

We believe that in the radio industry there have been fewer "stuffed shirts" than in almost any other line of commercial activity. Also, there certainly has been a glaring paucity of hundred thousand dollar per year salaries—such as have abated R. F. C. enthusiasm for loans to other industries in distress.

The radio industry as represented by the receiver manufacturers has suffered mostly

from unprofitable retail prices. Causes ascribed include fly-by-night, irresponsible, "gyp" competition, and dumping. Dumping was the second phase of over production.

Government control of industry will prevail for a period of two years under the bill, which declares the existence of "a national emergency productive of widespread unemployment and disorganization of industry, which burdens interstate commerce, affects the public welfare and undermines the standards of living of the American people" and defines the policy of Congress to be "to remove obstructions to the free flow of interstate commerce which tend to diminish the amount thereof; and to promote the organization of industry for the purpose of cooperative action among trade groups, to induce and maintain united action of labor and management under adequate governmental sanctions and supervision, to eliminate unfair competitive practices, to reduce and relieve unemployment, to improve standards of labor, and otherwise to rehabilitate industry and to conserve natural resources."

To this end, the industries of the country are to develop codes of "fair competition" which, upon approval by the President, are to constitute legal requirements, with fines ranging up to \$500 as penalties for violations.

Following adoption of a code, or its enforced application upon an industry which fails to act voluntarily, all members of the industry affected, engaged in interstate commerce, will be required to secure Federal licenses, failure to do so to be punishable by a fine not exceeding \$500 or by imprisonment for not more than six months, or both.

The designated "period of two years" should be viewed as a period of great opportunity for the radio industry. It will be a period of opportunity for constructive, cooperative leadership, a period during which there is likely to be an early separation of the builders from the destroyers.

Donald Mc Nicol

Editor

Precision-built?

.... OF COURSE
but more than that!



No. T20 Series, with switch.



No. T70 Series, with switch.



No. T75 Series with switch.



No. 11 Switch, for panel mounting
No. T, for unit mounting.

● You expect precision workmanship in most measuring instruments, in fine tools and in machine parts. These must be amazingly accurate if they are to be of worthwhile service . . . You'll find this same watchlike precision in the Volume and Tone Controls made by Chicago Telephone Supply Co. . . . But expect more than precision workmanship when you examine these fine variable resistors. Not only are they precision-built. You'll find them precision designed, as well.

That's a part of the service rendered by our Engineering Department that is vital to every manufacturer of radio receivers. It insures not only fundamentally correct designs, but also the use of materials that are absolutely correct for each particular part. It insures also the utmost watchfulness and care during every stage of manufacture.

Our engineers know full well how all-important is the matter of care—accuracy—precision—*vigilance* in the making of such delicate parts as these. For these units must be everlastingly *quiet*, and as permanently trouble-free as human ingenuity and skill can make them.

Frankly, we believe you'll find the precision-quality we build into these units a mighty comforting thing to bank on. When your merchandise has jumped the final hurdle in its journey to the consumer, and is being judged solely on its performance in the acid test of daily use, the integrity of its components is a vital necessity—Make sure that your Volume and Tone Controls are *right* by specifying those bearing the CTSC trade mark.

Any engineering aid we can render is yours for the asking. Let us help smooth out some of your variable resistor problems. Send us your specifications today.

CHICAGO TELEPHONE SUPPLY CO.

HERBERT H. FROST, Inc.

SALES DIVISION

General Offices ELKHART, INDIANA and Plant

The finest radio-equipped motor cars depend upon Allen-Bradley Suppressors for satisfactory radio reception. Profit by the experience of the leaders and standardize on Allen-Bradley Suppressors.

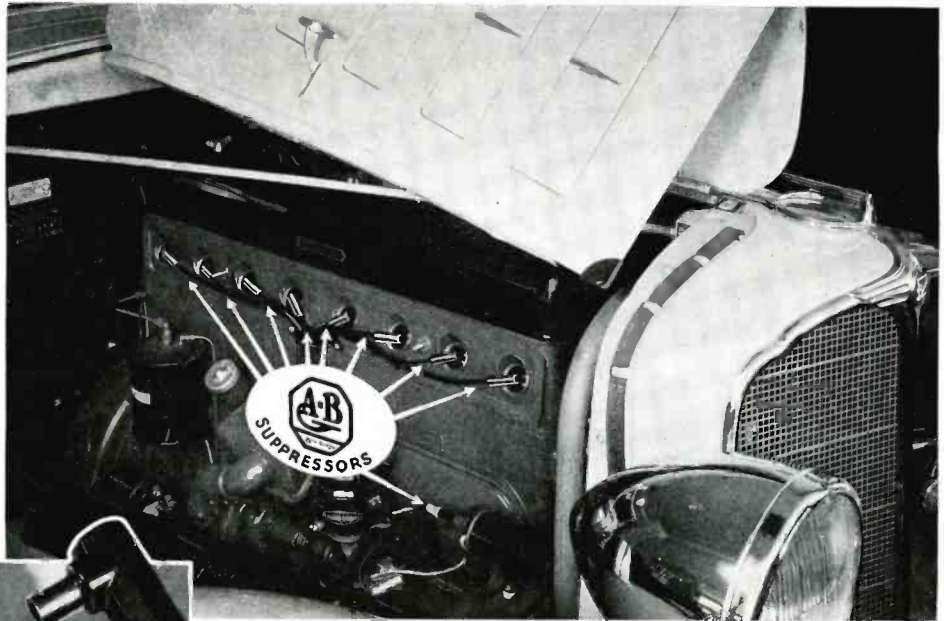

SPARK PLUG RESISTORS by Allen-Bradley

The world's foremost manufacturers of auto-radio receivers are enthusiastic about the high suppression efficiency of Allen-Bradley Suppressors. They also prefer these long-lived spark plug resistors because:

- 1- They do not "open circuit" in service and cripple the engine.
 - 2- They do not "drop" in resistance and fail as suppressors.
 - 3- They do not have a "high voltage characteristic" which sharply decreases the suppressor resistance during each spark discharge and thus defeats the purpose of the suppressor.
 - 4- They do not fail from exposure to oil and water.
 - 5- They do not break due to car or engine vibration.
- The resistors are enclosed in rugged, non-arcing bakelite casings—not in brittle ceramic material.

The superiority of Allen-Bradley Suppressors can be easily demonstrated. Our engineers will gladly supply data and performance curves on resistors for your requirements. Write us today.

A TERRIFIC LIFE TEST

Allen-Bradley Suppressors are tested in laboratory and field under all extremes of temperature, moisture, and other conditions in automotive service. There is no guesswork—prolonged tests protect the car owner against annoying failures.

ALLEN-BRADLEY COMPANY, 126 W. Greenfield Ave., Milwaukee, Wisconsin

RADIO ENGINEERING

FOR JUNE, 1933



RMA Prepares to Operate Under "Industry Control" Plan

With trade association membership declared to be an imperative necessity under the new "industrial control" law, a general invitation to all makers of radio products to join the RMA is being extended. All non-member radio makers are asked to communicate and file membership applications with RMA headquarters, 1317 F Street, N.W., Washington, D. C., and as soon as possible.

FEATURING the ninth annual convention of the Radio Manufacturers Association at the Stevens Hotel, Chicago, June 6, was consideration and definite constructive action for operations of the radio industry under President Roosevelt's industrial recovery program. A special RMA committee to begin work toward a voluntary "code" for the radio industry under the new plan for government "industry control" was created without a dissenting vote at the RMA membership meeting. The Association's board of directors was empowered to "do anything that may be required by the industrial recovery act in cooperation with the federal government."

The committee of leading national radio manufacturers appointed to work with the government in administering the new law and cooperate with the federal industrial administrator consists of W. Roy McCanne, chairman, president of the Stromberg-Carlson Company, Rochester, N. Y.; Paul B. Klugh, of Chicago, vice-president of Zenith Radio Corporation; Arthur T. Murray, of Springfield, Mass., president of the United American Bosch Corporation, and S. W. Muldowny, of New York, chairman of the National Union Radio Corporation. The committee immediately prepared to compile industry data in anticipation of early passage by Congress of the new legislation.

Fred D. Williams, of the P. R. Mallory Company, of Indianapolis, Ind., was unanimously reelected president of the RMA. The board of directors also was reelected. Leslie F. Muter, of the Muter Company, of Chicago, was elected treasurer; Bond Geddes was reelected executive vice-president, general manager and secretary, and John W. Van Allen of Buffalo, general counsel.

The RMA board includes the following, elected for three-year terms: J. Clarke Coit, Powel Crosley, A. Atwater Kent. Paul B. Klugh and George K. Throckmorton; for two-year terms: E. T. Cunningham, W. Roy McCanne, W. S. Syming-

ton, A. S. Wells, and S. W. Muldowny; for one-year term: Arthur T. Murray, James M. Skinner, William Sparks, LeRoi J. Williams, George Lewis, Leslie F. Muter, Arthur Moss and Richard A. O'Connor.

A nation-wide "Radio Prosperity Campaign" next fall, including outstanding broadcasting during a "Radio Progress Week" in October, was outlined. Earl Whitehorne of New York, long identified with radio interests, will be director of the prosperity campaign.

Under direction of Chairman Leslie F. Muter, the parts, cabinet and accessory division was reorganized at the annual division meeting in Chicago, June 6, during the convention. New chairmen for ten committees of the division were chosen and will develop detailed work for their members during the coming year. The various committees with their chairmen follow: Carbon Resistors, H. E. Osmun, chairman; Wire-Round Resistors, Leslie F. Muter, chairman; Variable Resistors, Arthur Moss, chairman; Fixed Condensers, Richard A. O'Connor, chairman; Variable Condensers, Lloyd Hammarlund, chairman; Cabinets, N. P. Bloom, chairman; Audio and Power Coils and Wire, Whipple Jacobs, chairman; Transformers and Chokes, C. H. Bunch, chairman; Sockets, H. H. Eby, chairman, and Instruments, Robert Williams, chairman.

The RMA annual meeting was attended personally by nearly 90 per cent of the membership. There were also two meetings of the board of directors and separate meetings of the four Association divisions: the Set Division, Chairman Arthur T. Murray; Tube Division, Chairman S. W. Muldowny; Parts, Cabinet and Accessory Division, Chairman Leslie F. Muter, and Amplifier and Sound Equipment Division, Chairman Richard A. O'Connor. All divisions heard annual reports of important work done during the past year and made plans for comprehensive future activities, in the interest of all manufacturing interests in the RMA membership.



In this Sparton model, three speakers in an arc of a circle provide 155 square inches of sound-recording speaker surface. This application of principles in acoustical reproduction eliminates distortion and provides performance superior to dual-speaker arrangements.

PARTS AND ACCESSORIES For Radio Receivers

DURING the past three years considerable progress has been made in the development of commercial standards for parts and accessories for radio receivers.

Through Leslie F. Muter, of Chicago, chairman of the RMA Parts Division, and Floyd C. Best, of Elkhart, Indiana, Standards Committee chairman, parts manufacturers are now contributing proposals and data to develop new and simplified commercial standards and thus effect substantial savings for receiving set manufacturers as well as makers of parts.

During the depression years, particularly, the competition in the parts field has been very keen. Low grade as well as high grade products have been marketed. Many radio receivers are in service made up largely of parts which make a poor showing except in the 50-kw. areas.

Condensers

In the matter of condensers radio must be credited with noteworthy progress. Before the advent of radio a one-half microfarad condenser consisted of a wood box container for the conducting and insulating elements, the box about six inches square and one inch thick. A standard three microfarad condenser weighed about fifteen pounds. The fractional unit capacities employed in radio made possible greatly reduced dimensions. The evolution of the electrolytic rectifiers of pre-radio days into electrolytic condensers—wet and semi-dry—permitted reduced dimensions for low capacity condensers for receivers, and also made for reduced costs. The small tubular condenser units have contributed to the

success of the miniature receivers now widely used. The dependability of by-pass and trimmer condensers of modern manufacture is quite remarkable.

Condensers of variable capacity also have been very materially improved in recent years. In superheterodyne construction for tracking use condensers have been subjected to close engineering studies with the result that condensers properly designed for the purpose now are available which have dependably uniform characteristics.

The dry electrolytics with single section cans one inch in diameter, for by-pass and filter uses are made in forms permitting of various mountings, thus enabling receiver designers to locate condenser units in any available space.

There are still many uses in radio for the small mica condensers molded in Bakelite. These range in capacity from .04 to .00004 microfarad.

Resistors

Resistors as shunts across spark gaps for the purpose of suppressing spark disturbance to radio receivers mounted in automobiles, presented a challenge to the manufacturers. These resistors perforce had to withstand much mechanical jarring without likelihood of circuit opens. The ohmic resistance must remain constant once applied to the car system. They should not have high voltage characteristics which act to decrease the suppressor resistance during each spark discharge.

Several resistor manufacturers were successful in meeting these requirements.

For relatively low ohmic values where measuring

instrument precision is desirable wire-wound resistors have wide application.

In the 1,000 to 5,000 ohms range the molded resistance units have been widely accepted.

With grid leaks commonly used with detector tubes and with resistance-capacity coupled audio amplifiers, a too low resistance value reduces the sensitivity of the receiver while if the resistance is too high the receiver may howl or choke on strong signals. With respect to the bias resistance from cathode or filament center tap of a tube to chassis or negative of plate current supply good practice prescribes that the resistance should equal one thousand times the rated negative grid bias of the tube in volts divided by the rated plate current in milliamperes.

In modern receivers the number of resistors is large compared with circuit requirements of a few years ago.

Sockets

In no element of the radio receiver, except tubes, has there been more worthwhile progress than in the manufacture of sockets. Such products as the simple unit with spring reinforced contacts for tubes of all types, and the rivetless unit are examples of real progress along this line.

Volume Controls

Several companies have produced excellent volume controls which have made possible improved radio reception. During the past year a considerable amount of technical information has been published on this subject, in RADIO ENGINEERING.

Transformers

In ten years vast improvement has been made in audio transformers used in the output of radio receivers. As soon as it was realized that there must be sufficient wire in primary windings to provide the required impedance and that there should be a resistance of 200 megohms upward between the two windings and core, crackling and frying of audio outputs disappeared.

Loudspeakers

Although American manufacturers were building loudspeakers as early as 1911 it was not until 1926 that satisfactory moving-coil speakers became available. In 1927 attempts were made to obtain wider response by employing dual speakers. During the following five years economy, low prices for receivers and space limitations tended toward improving single speakers. Loudspeakers then came to be known as "magnetic" or "dynamic." In the latter the force that drives the diaphragm is developed by the interaction of the current in the driving coil with the lines of magnetic force crossing the air-gap in which the coil vibrates. With a driving coil of a given size, the efficiency is proportional to the lines of force per unit area crossing the gap—that is, to the flux density.

The present tendency toward the employment of loudspeakers remotely controlled and toward the renewed incorporation in receivers of two or three loudspeakers is a bid for greater volume, wide frequency coverage and distortionless reproduction.

The outstanding work done by one company during the past few years is indicative of what has been going on in this direction. Recognizing the popularity of miniature receivers this company sensed the opportunity to add what was lacking, by adding an auxiliary speaker.

This speaker is installed in a suitable cabinet, located at any convenient place in the home. The cabinet is smaller than the conventional console, and its appearance with respect to authentic period designing is not restricted by the installation of tuners, dial knobs, etc. It merely contains the speaker and a pair of small leads, the two together no larger than a No. 16 wire being led to one or more locations where the small receiver may be located. The small receiver is then used throughout the household according to the wishes of the family, but it can be connected to the auxiliary speaker merely by inserting a small plug into a suitable jack, whereupon sufficient volume is obtained for any home and a degree of fidelity exceeding that incorporated in nearly all present day console receivers with conventional speakers.

The tuning and control volume is done at the arm chair with the small receiver. No auxiliary amplifier or any other equipment is used between the receiver and the speaker, and the small receiver still has its own individual speaker as a part of it, so that its utility is the same as it is in its present form.

Materials, General

Of the three main active materials in electrical apparatus, conductors, insulation and magnetic material, there has been a wide variation in development. Copper for conductors is practically the same today as it was thirty years ago. Insulation has advanced considerably but magnetic materials have, through industrial research, gone through most important changes. The core materials and core structure of modern transformers and chokes show improvement. Also, there have been advances in shaping inductance units, such as the Polydorff iron developments in the United States and the ferro-cart coil inventions in Europe.

Molded Products

Radio furniture, as this concerns cabinet housing for radio receivers, has drawn upon the genius of the fabricators of materials. Various synthetic molded products have been introduced in radio receiver manufacturing which have contributed toward neat appearance of the finished product and made possible small units without loss of rigidity and strength. Molded wood products also have found an acceptable place in receiver manufacture.

The general acknowledgment in other countries of the superiority of American radio receivers, both in respect to performance and appearance, is a tribute to the rapid progress made here by parts manufacturers in perfecting the many elements that go to make up the modern receiver.

Special Equipment

In the manufacture of receivers for automobile, air-plane and motor-boat use a long list of special parts and fittings is required. Roof and under-chassis antenna plates are in various varieties. In many installations loudspeaker units are completely inclosed in cylindrical aluminum cases provided with clamping studs. Shielded cable also is widely used in these installations for the purpose of limiting inductive disturbances.

For the rapidly increasing number of centralized radio systems for hospitals, hotels, schools, apartment buildings, etc., special antenna systems have come into use. These systems also have called for many designs of panel boards with their required complement of meters and switches.

Every new extension of radio develops a demand for new accessories, new parts and new designs.

Automatic Regeneration

By R. W. TANNER

AUTOMATIC regeneration has always been the hope of engineers and experimenters since the regenerative circuit was first invented. It is now a possibility through a development recently completed.

While the invention can be applied to the broadcast receiver to good advantage its greatest value will be on the short waves where the elimination of reaction on the tuning must be accomplished for ease of tuning. What could be more valuable in a short wave receiver than regeneration which requires only one initial adjustment?

In Fig. 1 is shown the fundamental circuit with a 27 detector tube. The inductance L is the usual grid coil and L1 is the regeneration coil. Both L and L1 are tuned to resonance with the incoming signal by means of a two-gang condenser C. The r-f. currents in the detector plate are fed to the tuned regeneration circuit, L1-C, through a blocking condenser C2. The capacity C1 is a coupling condenser.

If L and L1 were magnetically coupled and no capacity at C1, the plate feedback currents would be stronger at the low capacity end of the tuning scale. With no magnetic coupling between L and L1 and a capacity at C1, the feedback would increase at the high capacity end of the scale.

With proper coupling between L and L1 and capacity

coupling through C1, we can adjust the value of regeneration at a suitable point where it will remain constant over the entire tuning scale.

The circuit is not exactly complicated but considerable accuracy in the coils and tuning condenser is a necessity. The length of leads in both tuned circuits *must* be the same and the condenser trimmers must be adjusted accurately. The value of C1 and degree of magnetic coupling is entirely experimental. Coupling to the antenna cannot be too great otherwise detuning of the detector grid circuit will result in throwing the circuit out of balance, as well as causing dead spots in the regeneration.

The r-f. chokes in the detector plate circuit are of considerable importance in obtaining smooth, constant operation. RFC-1 should be capable of blocking the r-f. currents within the tuning range. RFC-2 may be 85 millihenrys and C3 250 mmf.

Automatic regeneration is especially suitable to a short

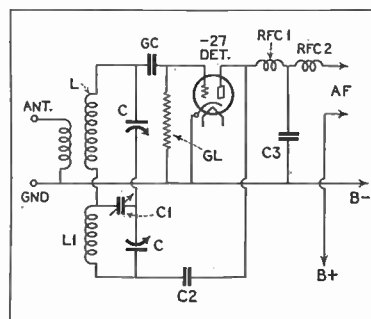

Fig. 1. Automatic regenerative circuit.

wave superhet, no more than one high-gain i-f. stage being then required. Image frequency interference is reduced to a minimum by the added selectivity, the sensitivity being all that one could desire.

Considerable work is being done with this new idea, applying it to various circuits and with different tubes. Later constructional data will be available.

◆ ◆ ◆

OPERATION OF NEW ANTENNA AT KYW

SIX months ago KYW made first use of a new type of antenna, that in effect consists of two vertical radiators, so spaced and properly adjusted in such a manner, as to concentrate the larger portion of the radiated energy in the directed direction. The unique feature of this installation was the utilization of wooden masts for the support of the conductors which radiate the 10 kilowatts of KYW's 1020 kilocycle frequency.

The main antenna at KYW, generally referred to as the exciter antenna, consists of a wooden mast which supports a section of copper tubing 204 feet in length. When first installed, an attempt was made to work the antenna as a half-wave radiator. A tuning coil was placed midway between the top and bottom of the pole and at a height of about 100 feet, and current fed by means of a two-wire transmission system to the transmitter. This particular system presented some difficulty in the matter of tuning and adjustments and after some experiments were made it was decided that a quarter-

wave, under the circumstances would be more feasible. Since January 5, 1933, the exciter antenna has been worked as a quarter-wave, its advantages over the half-wave being that it is little affected by weather conditions and can be tuned and adjusted at the base of the mast. Also as the present method of operating the quarter-wave antenna makes use of a ground consisting of copper sheets and radial wires, the wooden pole is very nearly at the same potential as the antenna itself, thus doing away with the possibility of loading a considerable portion of the radiated energy into the supporting mast.

When the antenna was first installed, three sets of guys, consisting of four guy wires each, were made use of to hold the mast erect. The topmost set of guys was approximately 140 feet above ground. There remained, unsupported, a 60-foot section of the mast at the top. It was decided that this presented a hazard in the case of high winds or ice collecting, and an additional set of guys was installed and attached to the mast, approximately 175 feet from the ground.

The CATKIN Tube

Largely replacing glass, an envelope of copper serves as anode

EUROPEAN tube manufacturers have introduced new radio receiving tubes, adopting from transmitting tube practice the metal container which serves also as the anode.

Fig. 2 shows a view of the screen-grid tube before the base has been attached. Fig. 1 shows the tube with base ready to be pushed up into place.

The new tubes embody various desirable features, such as greater uniformity, smaller dimensions, less liable to breakage, ease of packing and shipment, and requiring reduced shelf space.

The tubes available thus far are the screen grid, triode, and pentode, also a variable- μ s-g. type.

In the internal construction of the new tubes nearly all bends and welds are avoided from wire supports. Also, the inside electrodes are accurately and rigidly positioned within the anode-envelope by strong mica washers.

Glass is improved upon as a dielectric by substituting for the glass "pinch" a mica insulated pressed steel clip.

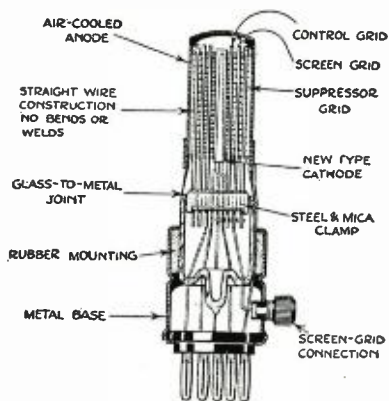

Fig. 3. The pentode unit.

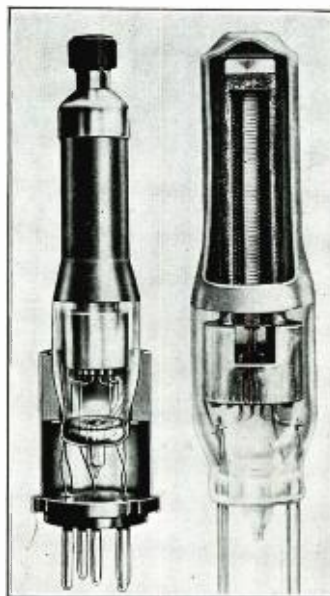

Fig. 1.

Fig. 2.

Fig. 1. A sectioned base of the Marconi Catkin. The shockproof rubber mounting which is used on all types is clearly visible.

Fig. 2. Interior view of Marconi s-g. Catkin. The cut-away anode and screen show the whole construction; this is the tube as it appears before the base is added.

Below this the wires are well spaced and taken out through a glass seal which forms the lower part of the electrode container.

The frequently disturbing sound vibrations which cause movement of tube electrodes, and thus produce a type of hum are, in the Catkin tube, obviated by the method employed to give it a non-microphonic mounting.

A short section of glass tube is joined to the copper envelope, the latter tapered to a thin edge which snugly fits the glass, being fused with a borax flux.

The reduced size of the tube is indicated by the measurement 125 mm. by 33 mm. (the triode $3\frac{3}{4}$ inches high by $\frac{1}{2}$ inch wide at the top).

The precaution of having the tube secured to the base by a rubber clamp limits the sound conduction path to the thin conducting wires attached to the contact pins, constituting an excellent non-microphonic mounting.

Of the tubes already available the characteristics of the s-g. detector amplifier are:

Filament volts	4
Filament current	1 amp.
Anode volts (max.)	200
Screen volts (max.)	80
Amp. factor	1,120
Impedance	350,000 ohms
Mutual conductance	3.2 ma./volt
Grid anode capacity003 μ f
Anode—earth capacity (unshielded)	6.0 μ f
Anode—earth capacity (shielded)	9.0 μ f
Grid—earth capacity	11.5 μ f

A Study of Hum Generation in Vacuum Tubes

As Affected by Heater Design

By
 J. J. GLAUBERT†
 AND
 A. G. CAMPBELL* †

EVER since the introduction of the types '36, '37 and '38 tubes in 1931, there has existed a feeling that these tubes are suitable for operation only with d-c. applied to the heater. As originally brought out, these tubes contained heaters of the straight-through type, a single coiled filament concentrically located in the cathode sleeve, and since no provisions were made for hum cancellation the tubes were not suitable for a-c. heater operation. The hum is due primarily to the magnetic field created by the filament current modulating the electron stream between cathode and plate. Most tube manufacturers are still using this form of heater construction, thereby limiting the application of the 6.3 volt tube to a d-c. heater supply. Realizing this limitation the Arcturus Radio Tube Company in 1931 developed a double hairpin type of heater which provided for hum cancellation. All Arcturus 6.3 volt heater tubes employ this type of heater and can therefore be used on either a-c. or d-c. supply voltages.

It is the purpose of this paper to compare the hum developed in the 6.3 volt tubes with that developed in the standard 2.5 volt heater type tubes, and thereby to show that because of the lower hum levels developed in the former type that the 2.5 volt tubes do not present sufficient advantages to have new tubes developed around this type of heater.

Description of Apparatus

The apparatus itself is thoroughly shielded from external disturbances and is placed in a shielded room as

†Chief engineer, Arcturus Radio Tube Company.
 *Research engineer, Arcturus Radio Tube Company.

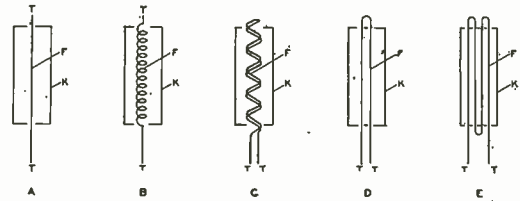

Fig. 2. Types of heaters.

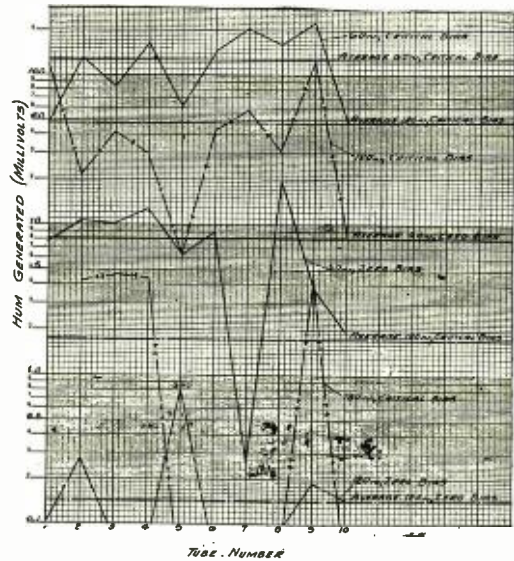

Fig. 3. Type 57. Filament as in Fig. 2 (C).
 Critical bias = 5.55 v.
 Cathode bias = 7.35 v.

an additional precaution against the influence of disturbing stray fields. Without a tube in the test socket the measured disturbance is 300 microvolts, most of which is at 60 cycles. Except for the 60 cycle a-c. source used as a filament heater supply, batteries are used throughout.

The tube whose generated hum is to be determined is connected as a self-biased anode-bend detector as shown at A in Fig. 1. The cathode is maintained at a positive potential with respect to ground by means of the 50,000-ohm resistor in the cathode circuit. The filament midpoint can be adjusted to any positive d-c. potential V above ground by means of the potentiometer P. The output circuit is resistance coupled to the input circuit of a type '24 tube used as a high gain linear voltage amplifier, having a measured gain of 143. A switch S, provides for the measurement by means of the anode-bend

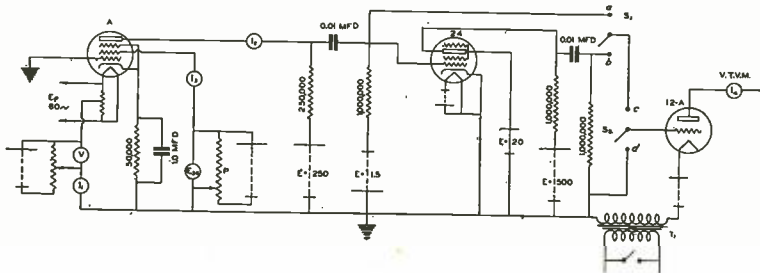

Fig. 1. Diagram of hum analyzer.

rectifier vacuum tube voltmeter, of the voltage at either the amplifier input or output.

A transformer T_1 , supplies audio frequency from a standard audio oscillator to the square-law vacuum tube voltmeter input. A harmonic analysis of the voltage generated by the tube under test is made by superimposing the voltage generated at the transformer secondary of T_1 , upon the voltage at either points a or b of switch S_1 . The audio oscillator is tuned to a frequency slightly higher or lower than that of the harmonic under observation. The beat frequency produced by the superimposition of these two frequencies upon a square-law rectifier appears on the microammeter I_4 connected in the output circuit of the v.t.v.m. and is maintained at a frequency of not more than 20 cycles per minute, (the natural frequency of the meter is 50 cycles per minute). The d-c. plate current of the v.t.v.m. is balanced out in the conventional manner. The peak amplitude of the beat note is proportional to the product of the contributing amplitudes and the v.t.v.m. calibration constant. The amplitude of the beat note is measured by observing the maximum and minimum positions of the microammeter needle as it slowly oscillates back and forth. The amplitude of the known audio frequency is measured by throwing switch S_2 into position d. If the harmonic under observation is small, S_1 is thrown to position b

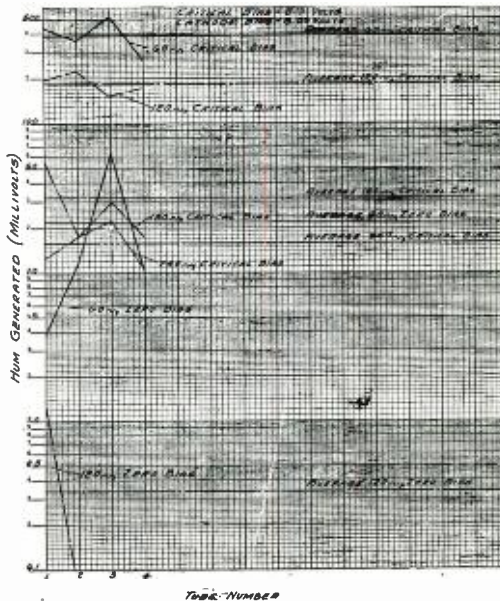

Fig. 6. Type 36. Filament as in Fig. 2 (B).

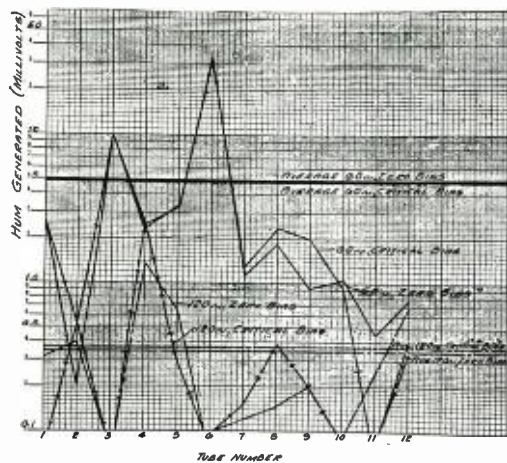

Fig. 4. Arcturus Type 57. Filament as in Fig. 2 (D).

Critical bias = 5.92 v.
Cathode bias = 6.05 v.

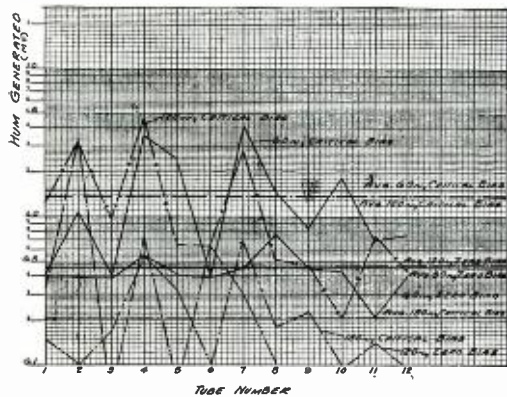

Fig. 5. Arcturus Type 77. Filament as in Fig. 2 (E).

Critical bias = 6.05 v.
Cathode bias = 6.19 v.

and the actual voltage developed across the output circuit of the tube under test is determined by dividing the amplitude of the harmonic between b and ground by the known gain of the amplifier. Then

$$E_2 = \frac{I_b}{4AE_1}$$

Where $\frac{1}{2} I_b$ = peak amplitude of the beat note
A = v.t.v.m. constant (microamperes per volt squared)
 E_1 = r.m.s. voltage of known frequency
 E_2 = r.m.s. voltage of harmonic

Voltages of the order of 0.1 millivolt can be measured with an accuracy of plus or minus 5 per cent. This method of harmonic analysis was described by C. G. Suits in an article entitled "A Thermionic Voltmeter Method for the Harmonic Analysis of Electric Waves," Proc. I. R. E. Jan. 1930.

Types of Heaters

There are five practical means of mounting the filament or heater within the cathode sleeve as shown in Fig. 2. At A is shown a single wire filament F mounted along the axis of cathode K. Inasmuch as tungsten is the only suitable material for heaters available at present, this type of heater construction is suitable only where a low voltage and high current can be tolerated. The high current produces a strong magnetic field which modulates the space current causing excessive hum.

In B is shown the straight through single coiled filament in use in many of the present 6.3 volt tubes. It is to be noted that no precautions for cancellation of the magnetic field produced by the current passing through the heater has been taken in either type A or B.

At C is shown the return helix type of heater in which provision for hum reduction is accomplished by causing the current to enter and leave in opposite directions, through two helically wound wires having a common axis. These helices have the same diameter and pitch and the turns are interlaced. This type of heater is applicable to both the 2.5 and 6.3 volt tubes.

At D is shown the single V or hairpin type of heater,

while at E is shown the M, or double V, or double hairpin heater construction. Because of the limited number of materials suited for vacuum tube heater use, and the limited space requirements, only the heaters shown at B, C and E are applicable to the 6.3 volt, 0.3 ampere tubes.

Hum Comparison

With 60 cycles a-c. as the supply source to the heater, a comparison was made between the heaters shown at B, C, D and E of Fig. 2, on a number of tubes. The generated hum was resolved into the fundamental frequency and its harmonics by the method described above. In each case measurements were made with the rated voltages applied to all elements of the tube, and with the filament center-tap at ground potential and then again with that value of positive bias on the filament which produces maximum hum. This has been termed the critical bias. It is of interest to note that the average critical bias is approximately 6 volts. The maximum and minimum values were 9 volts and 3 volts respectively.

In Fig. 3 are shown the results obtained on ten type 57 tubes with 2.5 volt heaters of the return helix type of Fig. 2C. The average 60 cycle component at zero bias is 8.1 millivolts and 127 millivolts at the critical bias of 5.55 volts. Fig. 4 offers a direct comparison, being the results obtained on the same type of tube but with the single hairpin heater of Fig. 2D. The average 60 cycle hum at zero bias is 5 millivolts and at the critical bias it is also 5 millivolts. At zero bias the only higher harmonic of any account in the return helix construction of Fig. 3 is the 120 cycle component, but for the critical bias, both the 120 and 180 cycle components are of objectionable magnitude. Measurement of the 180, 240 and 300 cycle components showed these to be negligible even at the critical bias for the single hairpin heater construction as is shown by Fig. 4. It should be borne in mind that the higher frequency disturbances are more objectionable, even though their actual level is low, because of the increased audio amplification and increased sensitivity of the ear to higher frequencies.

The reason for the marked difference in hum levels at the critical bias for the two types of heaters C and D of Fig. 2 is due to the necessity of spraying the return helix heater with an insulator to keep the turns from touching each other, whereas a two-hole extruded baked ceramic of higher insulation resistance is used with the single hairpin heater. As far as we know there has not been developed a sprayed insulator possessing the high insulating qualities of the baked ceramic.

A group of type 77 tubes having approximately the

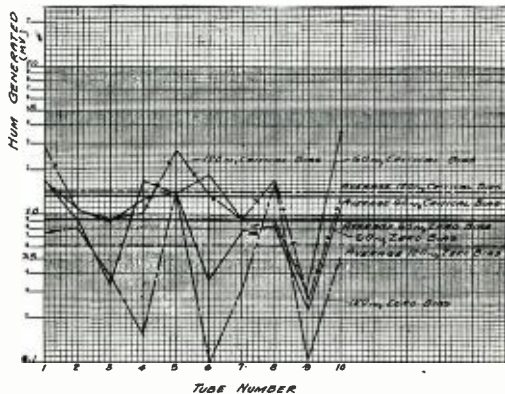

Fig. 8. Arcturus Type 36. Filament as in Fig. 2 (E).
Critical bias = 8.9 v.
Cathode bias = 8.28 v.

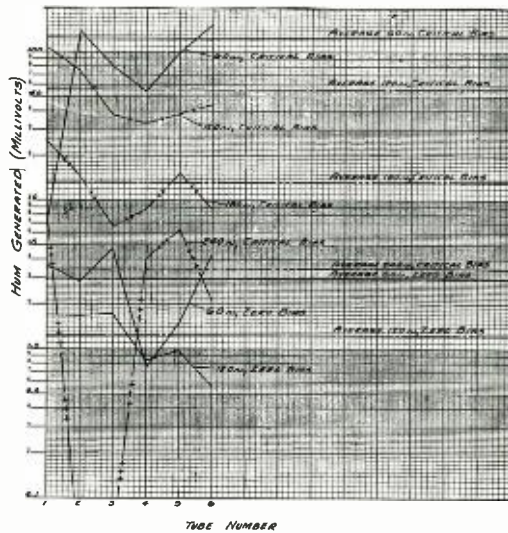

Fig. 7. Type 36. Filament as in Fig. 2 (C).
Critical bias = 6.9 v.
Cathode bias = 8.11 v.

same characteristics as the type 57 except for heater voltage and current was next studied. The heater construction shown in Fig. 2E was used. An extruded four-hole ceramic is employed. The average 60 cycle component at zero bias was 0.45 millivolt while the maximum obtainable with a 6.05 volt average bias was only 1.5 millivolts as shown in Fig. 5. It is of interest to note that although the third, fourth and fifth harmonics are negligible for the single hairpin type of heater as was pointed out in reference to Fig. 4, the heaters with the double hairpin of Fig. 5 contain a measurable amount of third harmonic component at the critical bias but a negligible amount at zero bias. The reason for this is not apparent but may possibly be due to the higher operating temperatures of the filament, and therefore the resulting higher conductance of the ceramic insulator.

From the above it may be concluded that the double hairpin construction generates a lower hum voltage than either the return helix or single hairpin heaters.

A comparison was next made between three differently constructed type 36 tubes employing 6.3 volt heaters as shown in Fig. 2B, C and E. Fig. 6 shows the high hum levels obtained when using the single coil straight-through heater in which no provision for hum reduction has been made. Since the loop formed by the lead wires and filament entirely surrounds the tube structure a high inductance is unavoidably obtained which results in a high alternating magnetic field intensity. In this construction the helix is placed inside a tubular ceramic surrounded on the outside by the cathode sleeve. It is to be noted that at the critical bias the higher harmonics up to 240 cycles per second are of high magnitude.

Fig. 7 is the result of a study of the return helix con-
(Concluded on page 17)

		HUM IN MILLIVOLTS						CRITICAL BIAS VOLTS
Type Tube	Heater	ZERO BIAS		CRITICAL BIAS				
		60 ~	120 ~	60 ~	120 ~	180 ~	240 ~	
57	Return Helix	8.20	0.14	128.	48.0	1.75	0.	5.55
Arcturus 57	Single Hairpin	5.00	0.35	5.0	0.37	0.	0.	5.92
Arcturus 77	Double Hairpin	0.45	0.47	1.5	1.37	0.21	0.	6.05
36	Single Coil	22.0	0.33	390.	184.	32.0	14.8	8.90
36	Return Helix	3.0	1.24	125.	56.0	13.1	3.5	6.90
Arcturus 36	Double Hairpin	0.92	0.62	1.35	1.41	0.	0.	8.90

Fig. 9

The Processing of Thoriated Tungsten Filaments

THE fundamental application of the filament in a vacuum tube is to provide a source of electrons. The electron as a natural unit of electricity was introduced in the latter part of the nineteenth century by Stoney. This, however, was not the origin of the true interpretation of the word and it was not until J. J. Thomson's work with his negative corpuscle radiation from heated surfaces in vacua that a true meaning, as we know it today, was placed in the annals of scientific perception.

The electron mass of 1/1845 of that of the hydrogen atom was established as being 9.999×10^{-28} grams, while its charge was shown to be 4.774×10^{-10} e.s.u. With this information at hand the way was cleared for electronic science to ever increasing usefulness. Undoubtedly, since the first practical filament in an evacuated envelope was of carbon, it follows that the first evidences of electron emission were noticed by Edison in conjunction with the development of the incandescent lamp.

When De Forest found the effect of varying the electronic charge about a heated body in a vacuum the immense possibilities of the vacuum tube became reality. The controlling of large amounts of power with a currentless voltage made the vacuum tube an instrument of infinite purpose. Researches in chemistry and physics rapidly converged, and the common basis of matter was the rule; communication, wire and wireless advanced by leaps and bounds; and a systematic investigation was begun to improve the vacuum tube.

Stefan-Boltzman formulated the equation:

$$P = K\epsilon A (T_s - T_0^4)$$

- P = power radiated
 - K = constant
 - A = constant
 - T_s = temperature of body
 - T₀ = temperature of surroundings
- } Kelvin

This equation being the relation of the energy dissipation of a perfect black body, by radiation. It shows that this radiation becomes greater as temperature is increased. From this equa-

The development and use of vacuum tubes in industry creating a new technical art.

By MILTON A. AUSMAN

tion the saturation current of a hot body was deduced, being:

$$I_s = AT^{\frac{5}{2}} e^{-\frac{b}{T}}$$

- I_s = saturation current
- A = constant, depending on parameter
- T = temperature (Kelvin)
- b = Stefan-Boltzman constant

Tungsten's high melting point made it an excellent material for the first practical vacuum tubes. At this point it is interesting to observe the coincidence of many developments that contributed to the rapid advance of the art in the early part of the twentieth century. Let us examine the history of tungsten from this point of view.

In 1781 K. W. Scheele isolated an acid from a mineral called Sheelite, which is a natural calcium tungstate. Bergman, one year later, derived the same acid from Wolfram or Wolframite, the mineral being composed of tungstates of iron and manganese. Wolframite is at present the leading source of tungsten (derived from the Swedish "heavy stone"). We are advised through British patent No. 11,848,

1847, that Oxland took out a patent for the manufacture of sodium tungstate, tungstic acid, and tungsten. Oxland later covered the use of ferrous-tungsten alloys which are the basis of high speed steels. The greater portion of tungsten ore comes from Asia, almost one-half of today's supply being mined in China.

In 1906-07 a process was developed for preparing tungsten filaments by extruding fine black tungsten powder through dies in combination with a dextrin binder. After this process the filament was heated in an inert gas to drive out the dextrin binder, a carboniferous substance. The volatile portion of the dextrin was eliminated but apparently the carbon combined with the tungsten to form WC and W₂C. We are advised that the filaments were very brittle when made by this method. Carbon content would account for this. Another process utilized a carbon filament burning in an atmosphere of hydrogen and tungsten hexachloride. This process was developed by Just and Hannaman (British patent No. 1949, 1905. It is again noticed that mention is made that the filament formed by this process is brittle due to its carbon content.

Another method of making tungsten filaments was the extrusion of tungsten powder with twice its weight of mercury cadmium amalgam. The amalgam being volatilized leaves a pure tungsten filament, very strong and exceedingly ductile.

None of these processes is at present in general use. In 1909 Coolidge developed a method of mechanical manipulation in conjunction with heat treating capable of making metallic tungsten from the powdered metal. This process is in general use today (British patent No. 23,499, 1909). Let us compare the amperes of emission from filaments of various materials as compiled by Van der Bijl, through the medium of Rich-

ardson's formula: $\frac{A}{I/\text{cm}^2}$, "A" being

Oxide coated.....	(8-24) × 10 ⁴
Tungsten	2.36 × 10 ⁷
Thorium	2.0 × 10 ⁸

It will be seen that the oxide coated

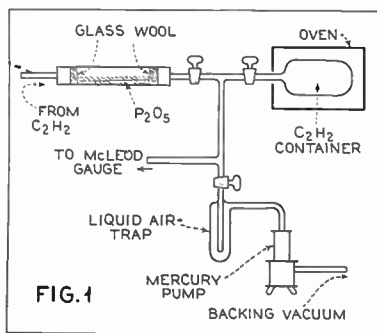

FIG. 1

Fig. 1.

filament's emission exceeds that of the thoriated filament type for the same energy consumption. This is due to the lower electron affinity of the coating used in the former case. Electron emission is a surface evaporation and the efficiency of the filament is quite naturally a function of the amount of work necessary before the internal balance of the atom is affected to the point whereby an electron may be freed from its influence. Thus, substances whose orbital (outer) electrons are held by a strong field are not suitable as the electrons are difficult to dislodge from the local effect by the dynamic acceleration caused by heat. It is therefore necessary to raise such substances to very high temperatures before they may be efficiently employed as cathodes. Such a substance is tungsten which has a high melting point.

Oxide filaments have not been found suitable for high-frequency use due to the difficulty of complete evacuation of tubes using this type of filament. During a period when electrons are flowing from filament to plate the filament is operating normally and safely but due to the rapid change of grid potential a great many electrons are caught between plate and filament and ionize the gas surrounding the filament, which drops rapidly back to the filament with a destructive action on the coating. This effect has been noticed in improperly exhausted thoriated filament tubes.

In 1923 Langmuir (Physical Review, 1923) found that filaments containing thoria (ThO₂) when raised to 2,600 K. contained a small percentage of metallic thorium and that these filaments showed a greater electronic activity. Above 2,600 K. ThO₂ is reduced to metallic thorium. If, however, after burning a filament at this high temperature it is immediately tested at lower temperatures the filament will show the approximate emission of pure tungsten. This is due to the evaporation of the metallic thorium from the surface of the tungsten. If the filament is operated at 2,000 K. for a short time the thorium will permeate to the surface of the tungsten, forming a layer of thorium atoms. Langmuir has shown that:

$$\text{Log}_{10}D = .21 - \frac{20,900}{T}$$

$$\text{Log}_{10}E = 7.76 - \frac{44,500}{T}$$

E = rate of evaporation
D = rate of diffusion
T = temperature (K)

The effectiveness of the filament being designated thus depends on the

balance between the rate of diffusion and the rate of evaporation the value never being greater than one, due to the fact that thorium evaporates much more rapidly from its own surface than from that of tungsten. Increases in temperature above 1,900 K. are fatal to the preservation of the thorium surface. Let us now tabulate a short table showing the emission of thoriated tungsten compared with pure tungsten:

Degrees K	Amperes per square centimeter Thoriated tungsten	Amperes per square centimeter Tungsten
1000....	9.12×10^{-8}	
1100....	2.51×10^{-8}	
1200....	3.98×10^{-5}	
1300....	3.98×10^{-4}	
1400....	3.09×10^{-3}	5.75×10^{-9}
1500....	1.82×10^{-2}	7.58×10^{-8}
1600....	8.15×10^{-2}	8.05×10^{-7}
1700....	3.39×10^{-1}	6.31×10^{-6}
1800....	1.15	3.92×10^{-5}
1900....	3.55	2.04×10^{-4}
2000....	9.55	8.92×10^{-4}
2100....	23.44	3.46×10^{-3}
2200....	53.70	1.14×10^{-2}
2300....	117.50	3.63×10^{-2}
2400....		1.02×10^{-1}
2500....		2.67×10^{-1}
2600....		6.48×10^{-1}
2700....		1.47
2800....		3.21

Reducing agents such as carbon, boron or tungsten carbide (British patent 215,348) may be introduced in the metallic powder before it is pressed into ingots. This introduction aids in the reduction of thoria to metallic thorium when the filament is flashed. However, it also appears that the function of these materials is to open the dense crystalline structure of the tungsten to allow the more rapid diffusion of the thorium to the surface of the tungsten through the interstices caused by

the carbon. In most cases, particularly in case of transmitting tubes, the carbon is introduced after the filament is mounted. This because of the difficulty of handling the tungsten when it is carbonized. Various methods are used to introduce this carbon.

In all cases that have come to the author's attention the carbon is introduced by burning the thoriated tungsten filament in a hydrocarbon gas or vapor. Both of these processes require extreme purity of the materials involved in the process in order to eliminate the possibility of poisoning the filament.

The method in which acetylene is used as a carrier of the carbon is illustrated in Figs. 1, 2 and 3. A resistance measurement of each filament should be taken prior to treatment. A number of tubes should be run on the carbonization system and an observation taken on each one with regard to resistance increase compared with the reading of the ammeter when the process is terminated. These measurements should be taken when the filament is cold. It will be found that resistance increases of from 35 to 45 per cent will give the greatest life. Study of Fig. 3 will show that the ammeter will indicate the increasing resistance of the filament as it absorbs carbon. Experimentation will clearly define a point where the filament has attained the required increase in cold resistance. Acetylene pressures of approximately 200 microns will be found satisfactory. Combinations of high pressures and high carbonizing voltage will result in a precipitation of free carbon particles on the press which may increase leakage.

Clean exhaust systems are essential and the elements should be thoroughly cleaned in a high temperature hydrogen furnace before sealing. This will facilitate the exhaust process and preclude the possibility of occluded gases from the elements poisoning the filament. Each tube, before carbonization should be thoroughly exhausted on a separate pumping system. The elements being cleaned thereon by high frequency heating. This makes possible the baking out of the tubes on the carbonization rack and eliminates certain volatile substances which may be deposited in the carbonization exhaust system and cause high vapor pressures to exist therein. Three constrictions are usually furnished in each tubulation, one for preliminary exhaust, one for carbonization and bakeout and one for the final exhaust. The final exhaust being both high frequency and static.

The acetylene (C₂H₂) used in filling the container should be as pure as possible. Provision should be made to bake the C₂H₂ container which should

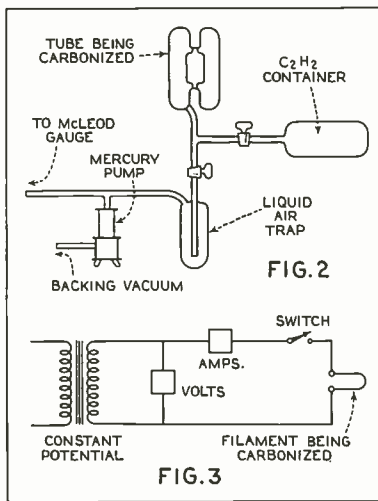

Figs. 2 and 3.

be thoroughly rinsed before using in a weak hydrofluoric acid solution, distilled water and alcohol in the order named. Although these precautions may seem unnecessary they assure a more uniform process and a smaller percentage of shrinkage. Baking of the C_6H_6 container should be at 500 C which makes it necessary that the container be of Nonex or Pyrex.

The C_6H_6 pressure in the container should be such that it may be easily controlled through the medium of the stop-cock in Fig. 1. It will also be noticed that the C_6H_6 in no instance is allowed to flow through the freezing trap because of its boiling point of $-72.2C$.

The method of carbonization using an inert gas such as hydrogen as a carrier for a volatile liquid rich in carbon, although not widely used, is ideal for production purposes. Its simplicity makes possible the use of unskilled employees. This process also may be more accurately controlled under production difficulties.

In Fig. 4 a stream of pure hydrogen is passed through a flow indicator over benzol (thiophene free C_6H_6) into a deep bell jar. The hydrogen being lighter rises to the top and displaces the air. The hydrogen is cleaned on its way into the apparatus by passing through a tube of hot copper turnings after it has been allowed to bubble through a weak acid, a weak alkali and distilled water solutions. However, before entering the manometer it is passed over phosphorous pentoxide (phosphoric anhydride acid (P_2O_5)) to eliminate all moisture.

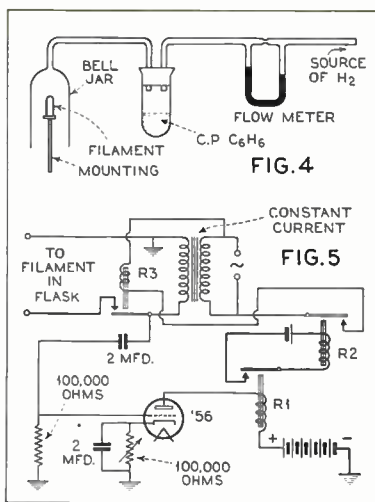

Figs. 4 and 5.

The hydrogen does not flow through the benzol but passes over the solution. The hydrogen flow being adjusted so that it does not pick up enough benzol to cause a precipitation of carbon when the filament is lighted. This adjustment may also be partially affected by varying the length of the tubing projecting in the benzol container. The vapor content of the hydrogen is naturally affected by the temperature of the benzol which when being cooled by the evaporation caused by the passing hydrogen causes a lowering of temperature which affects the vapor content of the hydrogen.

After the hydrogen has been flowing for a length of time to assure the

operator that all of the air has been displaced; the filament, usually mounted in the cathode assembly, is inserted in the bell jar well toward the top. This eliminates the possibility of the filament burning in an air-hydrogen mixture which may ruin the filament or even explode. Against the latter possibility the jar should be covered with screening to protect the operator. After the filament is inserted in the jar it should be tapped several times to dislodge air bubbles which may be clinging to the structure. Then relay No. 3 is held in. The voltage across the filament will be low due to the low resistance of the pure tungsten and as the filament takes on carbon and is increased in resistance the voltage increases across the vacuum tube voltmeter until it trips relay No. 1 in the plate circuit of the voltmeter, this releases relay No. 2 which in its turn opens the filament circuit. Relay No. 3 is of the type that requires manual resetting. The vacuum tube voltmeter cutoff point is regulated by the resistor in its cathode circuit.

In this method of carbonization the percentage of cold resistance increase should be from 40 to 60 per cent due to the different orders of WC resulting from this method of carbonization.

Attention should be called to the fact that the filament should be allowed to cool thoroughly before removal from the carbonizing flask.

Filaments that have been processed by both methods and in the completed tubes should be burned for ten seconds at 2800 K. and aged for thirty minutes at 2000 K. The processing of the filament is then complete.

EXPERIMENTAL BROADCASTING STATION AUTHORIZED IN COLOMBIA

The Ministry of Posts and Telegraphs granted permission to Manuel J. Gaitan to install in Bogota an experimental broadcasting station. The new station is authorized to use up to $7\frac{1}{2}$ watts power, and a wave length of 363 meters. It will be known as station HJ3ABH.

A STUDY OF HUM GENERATION IN VACUUM TUBES

(Concluded from page 12)

struction with sprayed insulation. The resulting hum voltages are of the same order as obtained with the same type of construction used in 2.5 volt heater tubes. Again it is noticed that the 6.3 volt heater construction gives a greater

harmonic content of the higher frequencies.

Fig. 8 shows the lower magnitude of hum generation found in Arcturus tubes employing the double hairpin heater with a four-hole ceramic insulator. The results are directly comparable to those obtained with the same type of heater used in Arcturus type 77 tubes as shown in Fig. 5.

Conclusions

The hum developed in both types of tubes employing the double hairpin construction for 6.3 volt operation is less than for all other types of heaters examined regardless of whether a 2.5 or 6.3 volt heater is used as shown in the summary table of Fig. 9.

Inasmuch as the cost of manufacture is approximately the same for the types of heaters studied, and since it has been shown that the 6.3 volt double hairpin design is most desirable from a consideration of generated hum, it may be concluded that all new tubes could and

should be designed around this type of heater, except in special cases. This would avoid the duplication of types differing only in heater supply voltage.

BOOK REVIEW

PRINCIPLES OF RADIO COMMUNICATION. By J. H. Morecroft, assisted by A. Pinto and W. A. Curry. 1075 pp. Cloth. John Wiley & Sons, New York, 1933. Price, \$7.50.

This is the third edition of Professor Morecroft's monumental work on radio. The wide coverage and thoroughness of the first two editions of this book made of the work a standard reference in engineering libraries and in the personal libraries of engineers engaged in all departments of radio. The present edition contains a large amount of new matter, bringing the book up to date in every particular.

Engineering Organization

By RICHARD F. SHEA*

The Chief Engineer

THE purpose of this article is three-fold. First, it may serve to give engineers an insight into the problems of the organizations to which they belong; secondly, it may suggest to engineering executives possible changes for the better in their present organizations; and, thirdly, it is hoped that this article will present in their true light problems, difficulties and details arising in the efficient organization of any large engineering establishment.

It might be said here that the organization considered is really only applicable to large companies; those making their own component parts, with few exceptions, and where weekly receiver production may run from five hundred to as high as ten or twenty thousand. Small companies may alter the plan to fit their needs. Departments may be eliminated where parts are purchased outside, and duties may be combined, but for the large companies it is felt that the following will be found to combine, as well as possible, efficiency with low cost.

The writer is a strong believer in departmentization, as contrasted to those organizations where many functions are combined in each engineer. True, great specialization is apt to result in waste and over-manning unless properly controlled, and may produce few all-around experts, but, on the other hand, too great a step in the other direction may produce equal or greater waste. In one engineering organization there are several high class engineers who are responsible for complete design on a receiver. One man, for instance, will receive the assignment of a ten-tube superheterodyne. This means that he must design all the component parts, incorporate them in the receiver, test it out; when it is finished, work it into production, and finally, see that production runs along smoothly on this job.

This system produces expert design

*President, The United Radio Laboratories.

men, but the waste and duplication may be excessive. Each design engineer builds up his own equipment. Often there is rivalry. Often work is duplicated without either knowing it, and the difficulty of standardization can readily be realized. Obviously, also one man's weakness may be another's strength, and one engineer may fall down on his job by lack of knowledge of power transformers, concerning which another may have a wealth of knowledge. Unless the head of such a department has intimate knowledge of each man's particular capabilities, or there are frequent conferences to compare notes, it is evident that the most cannot be obtained from the engineers under such a system.

By referring to the accompanying illustration it will be seen that the writer recommends a division of the engineering organization into five departments: research, production engineering, mechanical engineering, equipment design and inspection. Each of these departments has its head, responsible to the chief engineer, and each has his particular duties and responsibilities.

The following is a resume of these duties, together with explanatory remarks. It will also be indicated what equipment is usually required by each department.

It should be borne in mind that this chart is a fundamental diagram rather than a personnel arrangement. Thus, several duties may be performed by one man, or by several men. It indicates only the essential duties of an engineering organization, their allotment in various departments, and gives only a sketchy idea of engineering personnel. It might be mentioned, however, that an organization of this sort can hardly have less than 20 men, and very likely will include 50 to 100, in large companies.

The chief engineer is supposed to know more about what can be done along engineering lines than anyone in any other department, and his word in this regard should be respected. Abortive designs have been shoved onto an unsuspecting public in the past because the executives of a company forced unsatisfactory designs upon the man who should have had the say about it.

The duties of the chief engineer are to cooperate with the executives of the other departments; lend his experience to determine the engineering and manufacturing practicability, and cost of production, of proposals submitted by other executives, and to transmit the decisions of these executives to the proper men of his department to get the work done in specified time. There should be no outside interference with his department, as, otherwise, other work will suffer if schedules are upset.

The chief engineer must keep intimately acquainted with the work being done by every man in his department in these days of stringent economy, but this doesn't mean that he should know as much of the details of their jobs as the men working on them. It simply can not be done, unless a man is a mental giant. He is responsible for the proper coordination of effort in the organization, and must issue proper instructions to each department head to make sure that no hold-up will occur in the design.

Research

The research engineer is responsible for all design up to the stage where the model is released for production. His staff should include men for design on component parts, circuit design men, receiver design men, and a measurement division. Of course, an engineer may be an expert on parts design and also on complete receiver lay-out, or he may be particularly expert on power transformer design. In the very large organizations there may be sufficient work to warrant an engineer doing nothing but power transformer design, but usually the functions listed above will be performed by comparatively few men, which requires that each may work on various jobs.

The usual equipment necessary for research is parts measuring equipment, i. e. bridges, radio-frequency measur-

In this article Mr. Shea presents his ideas as to economical and efficient organization of engineering staffs for radio manufacturing plants.

ing setups, oscillographs, meters, tube voltmeters, magnetic test equipment, and other special equipment of such nature. For receiver design signal generators and shielded booths are necessary, and the usual testing equipment for continuity testing, etc.

Production

The duties of the production engineer take up where the research man leaves off. His is the job of getting the receiver into production, and of keeping it going along smoothly. He must check all component parts, make sure they are correctly designed from a production standpoint, perform the usual life tests on component parts and completed receivers, tubes, etc., to make sure they will stand up in service; work up production schedules for the guidance of the production department, bills of materials, assembly lists, and he must check all mechanical designs for production faults. Some of the duties listed may be placed under the mechanical department; bill of material work, for example. However, the writer believes that their proper place is as shown, as the production engineering department should have complete responsibility for getting an accepted design into production.

The production engineering department does not require much equipment, but what there is of it is rather large. It should have life testing equipment, condenser ovens, humidor, transformer test boards, breakdown setups, and some measuring equipment.

Mechanical

The chief draftsman is often the only mechanical engineer a company has. The writer feels that much production

grief can be avoided if a well-qualified mechanical engineer heads up this department, thus making it possible to delegate to him several important duties that lie outside the province of drafting. He should be the man to handle all mechanical design problems, about which so many good radio engineers are ignorant. He can save considerable money by minimizing waste due to impractical mechanical designs, without making up units to demonstrate faults. He should also control the experimental shop; should delegate the various mechanical jobs so that no important pieces of work shall lie untouched due to lack of realization of their importance. The responsibilities of the mechanical engineer include also the more routine drafting work, which can be handled by the chief draftsman.

Equipment

This section of the laboratory handles all design and maintenance of equipment for the other members of the engineering staff and for the factory test departments. In very large organizations this department may be split into smaller sub-divisions located near the production lines in which they are primarily interested; as, for instance, loudspeaker test equipment section, power transformer test equipment section, etc. But, in most organizations this should all be in one department. This section must work closely with other departments, as obviously the design of test equipment for the coils of a receiver depend upon the electrical characteristics of these coils, which must be obtained from the design man. The problem is further complicated by the fact that usually the equipment sec-

tion must work along with the research section, as valuable time will be lost if the equipment must wait on a final OK, before starting. Here may be waste, in the effort to avoid loss of time, as hardly ever does a design come out in the form it originally assumed, and consequently, equipment laid out from the original ideas must be revised as these ideas are revised. However, it is believed that this "waste" may be justified by the lost time avoided.

It is also the writer's opinion that the equipment section is the proper place for the stock of meters and laboratory equipment, where it can be periodically checked up and reconditioned. Such apparatus should be let out to the members on a checking system, so that any instrument can be readily located.

Maintenance of production test equipment is a very important phase of the work for which this department is responsible. It may be argued that the man who designed the test equipment is more fitted to keep it going, but it must be borne in mind that maintenance is necessary, and it may be undesirable to pull an engineer off a design job to send him out to fix test equipment. For this reason the writer maintains that there should be a man or men definitely responsible for upkeep, and they should be required to periodically check all test equipment.

Inspection

The writer belongs to that school which believes that the inspection department properly belongs under the supervision of the engineering department, rather than under production.

Since the engineering department is
(Concluded on page 21)

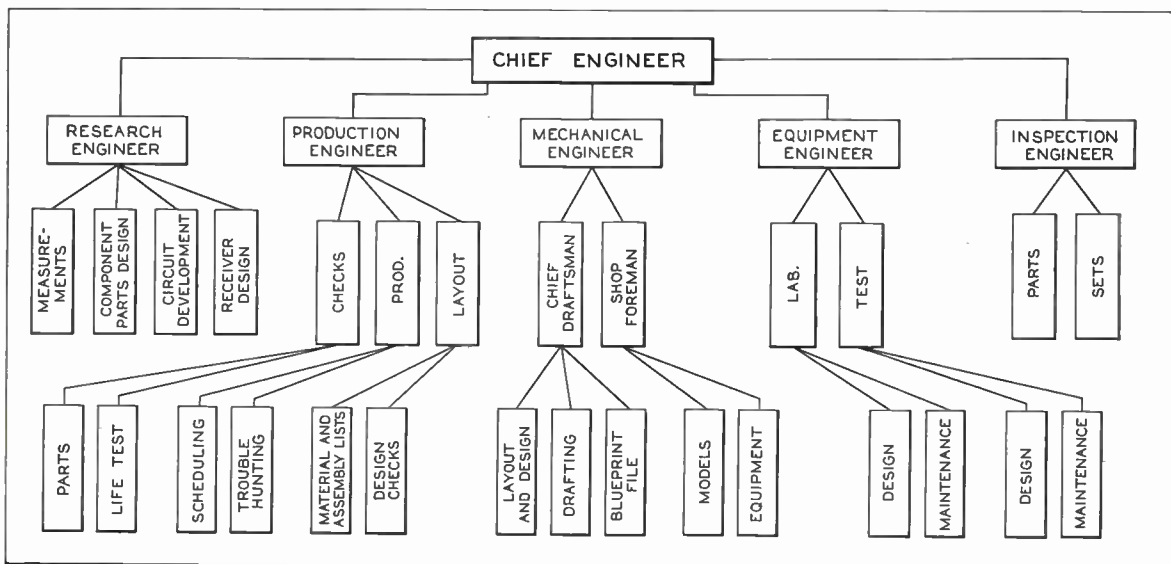

Functional diagram of a large radio manufacturing engineering organization.

Radio Distribution System for Apartment Buildings

By C. F. BOECK*

IN the early days of broadcasting, it was generally considered essential to provide a separate antenna for each broadcast receiver. This may easily be done in suburban areas, but is difficult in densely populated regions. Many apartment house roofs are cluttered with a maze of antennas which—constructed in accordance with the ingenuity of the various tenants—present a haphazard arrangement of unsightly appearance. To the users of the broadcast receivers in the building, however, such an arrangement presents many disadvantages more serious than those of appearance. To avoid the objectionable features of groups of individual antennas, the Bell Telephone Laboratories have recently developed a multiple channel radio distribution system which, although having a capacity of 3000 receivers, employs only a single antenna.

The objection to employing a group of individual antennas close together, is that each is not an independent collector because it is actually coupled through its electric and magnetic fields to the others of the group. Receivers of the radiating type connected to any of these antennas will introduce interference into all the receivers. Also, the signal delivered to a receiver will be reduced whenever another receiver tunes in on the same station. Besides this interference entering through the antennas, local disturbances are picked up by the lead-in wires, which have not

usually been properly designed or shielded.

Several attempts have been made to shield the lead-in wires from this local interference, but the results have not generally been satisfactory because sufficient consideration has not been given to the fundamental principles involved. Although the shielding has reduced the interference, it has reduced the strength of the broadcast signal at the same time. The reduction in strength of the signal makes it necessary to operate the receiver at high gain, and since most receivers are inherently noisy in the region of their maximum sensitivity, sufficient noise is generally introduced to offset the decrease in noise due to shielding. Thus while the ratio of noise to signal has been decreased at the input of the receiver, it has not been appreciably reduced at the output.

Various arrangements have been devised from time to time to overcome these objections, and to provide all apartments with suitable antenna facilities. In some instances coils or loops of wire have been built into the ceilings of the various apartments. In others, loops have been installed in the partitions. Such collectors are inherently inefficient, however, and the coupling between neighboring collectors is usually too close to avoid objectionable interference between receivers.

In the new system developed by the laboratories, known as the 3A radio distribution system, the various objectionable features of the earlier methods

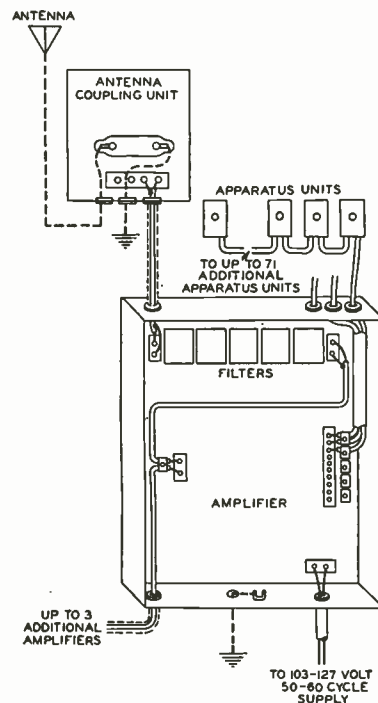

Fig. 1. Schematic of new radio distributing system.

have been eliminated. This system employs but a single antenna properly designed to efficiently collect all signals in the broadcast band. Most of the problems of the design center around the distribution of the signals to the numerous apartments in the building, with a minimum of attenuation.

This is fundamentally a problem of transmitting high-frequency currents, and may be solved by the principles employed in the design of long telephone circuits. Not only must the system transmit the signals faithfully and with a minimum of attenuation, however, but it must shield them from local disturbances. The system is thus based on an efficient and shielded distributing network fed from a single antenna, but includes in addition both antenna and receiver coupling equipment, and—particularly for the larger systems—amplifying equipment as well. A simplified diagram for such a system is shown in Fig. 1.

The antenna coupling equipment provides a means for connecting the antenna to the distribution system. It includes a coupling transformer, and an arrester to protect the system from lightning discharges. This unit is mounted in a weather-proof box which should be installed as close to the antenna as practicable.

Since a practical antenna obviously cannot collect sufficient energy to supply three thousand receivers and also overcome the coupling loss, an amplifier is provided to furnish the addi-

*Radio Development, Bell Telephone Labs., Inc.

Fig. 2. Receiver coupling unit.

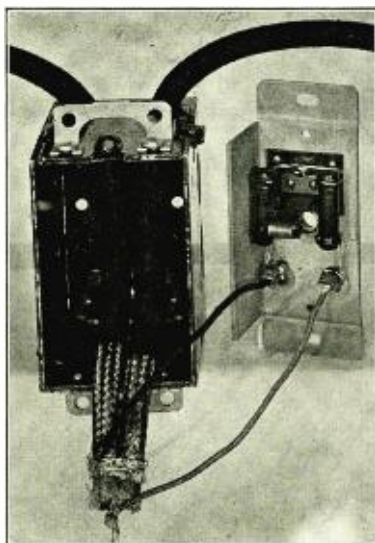

tional energy required. Associated with the amplifier are attenuating networks. These are selective volume control circuits which are used to reduce the level of any signal sufficiently powerful to overload either the amplifier or the receivers.

The amplifier employed has four stages and employs unipotential cathode tubes designed for low hum. It is operated from the usual 110-volt lighting circuit and requires no attention except for occasional maintenance purposes. Each such amplifier will supply as many as 750 receivers, and as many as four amplifiers may be connected to the same antenna. Ten outgoing circuits may be connected to each amplifier and each circuit has a capacity of seventy-five receivers. The length of a circuit, both from the antenna coupling unit to the amplifier and from the amplifier to the most distant receiver, is usually limited to 750 feet, which allows 1500 feet between the antenna and the most distant receiver. Although it is not expected that there will be many instances where more than 3000 receivers are required, it is possible to supply any number from a single antenna by employing additional amplifiers as repeaters.

The receiver coupling unit must provide a means of connecting the various receivers to the distribution circuit and at the same time of isolating them from

each other. Since many receivers are connected to the same circuit, the coupling unit must introduce a low shunt loss and at the same time introduce sufficient attenuation between receivers so that no interference or tuning reaction may be expected. A passive network is employed which introduces a shunt loss of only .02 db., but a loss between receivers of the order of 65 db. So effective is the arrangement that there is no detectable change in the volume or quality of the output of any receiver even when all the receivers connected to the system are tuned to the same station. One of the receiver coupling units and the method of connecting it to the

shielded conductor is shown in Fig. 2. The receivers themselves are terminated in plugs which are inserted into the jacks of a coupling unit.

A coaxial conductor is used exclusively for all wiring in this system. It provides an efficient transmission path for the radio-frequency currents and also shields them from local disturbances. A central copper conductor is insulated with rubber, and over the rubber is placed a sleeve of tightly woven copper braid. The central conductor forms the high potential side of the circuit, and the sleeve—which is grounded—forms both the shield and the return path. Over the shield may be placed a cotton braid or a lead sleeve, depending on whether the cable will be located in a dry or wet place. Its construction makes the cable flexible so that, like armored cable, it may be "fished" between building walls and partitions. At broadcast frequencies, the current, because of the skin effect, is confined to the outer surface of the central conductor and to the inner surface of the sleeve. The outer surface of the sleeve forms the shield and carries the disturbance currents which, without such a conductor, would affect the broadcast circuit.

With this system each receiver performs as though it were supplied from a separate and independent antenna, and any broadcast station is selected as desired. The increasing demand for radio facilities in large apartment buildings and hotels should provide a wide field of usefulness for this new distribution system.

SHORT-WAVE RECEIVER

WHAT was primarily a student's experiment, has turned out to be a practical thing. This applies to the experimental short-wave radio receiving station built by Carl Hedburg, student of physics at the University of Denver, School of Science and Engineering.

The set, made from miscellaneous laboratory odds and ends, with the adaptation of an old loudspeaker for reception, was, after further construction under the direction of Dr. W. H. Hyslop, of the School of Engineering, included in an exhibit of scientific student projects held in May.

Already, stations in Rocky Point, N. Y., Pearl Harbor naval station in Hawaii, San Francisco, and Buenos Aires have been heard in code.

ENGINEERING ORGANIZATION

(Concluded from page 19)

responsible for the design and installation of test equipment, it should control the use of that equipment. The equip-

ment section should be responsible for the issuance of proper operating instructions. The production engineering department should make up whatever line test cards are desirable, in order that the engineering department may be able to keep informed on the various production faults that predominate, and thereby avoid serious trouble from developing.

There are other functions that must be performed in engineering organizations; clerical, stock room, etc. These are easily fitted into the proper places in the picture and require little more than a passing word. Usually the clerical work is handled by one secretary, although possibly two may be needed, if inter-departmental correspondence is heavy. Stock is best maintained separately, with a checking system similar to that used for equipment for the larger stock, and a requisition system for materials to be used in models, etc.

There are certain functions that must be performed, if the product is to be properly presented for distribution in a highly competitive market. The lessening or curtailing of these functions will

act as a boomerang, ultimately. If an engineering organization is curtailed too far the result is two-fold. First, in a deterioration of quality, and secondly, in the piling up of work that must eventually be performed.

NICKEL-IRON ALLOYS IN RADIO TRANSFORMERS

The use of nickel-iron high-permeability alloys for radio transformers marks a definite advance in the design of compact and popular priced apparatus. The properties of high magnetic permeability and low losses shown by these alloys make possible a transformer giving improved performance combined with a very useful reduction in size and weight. The properties of the nickel-iron alloys and their adaptation to wireless transmission are described in terms comprehensible to the average student of wireless.

L. S. Crutch.—"The Story of the Small L. F. Transformer; the Advantages of Alloy Cores." *Wireless World*, Feb. 10, 1933, pp. 106-8.

A chronological history of electrical communication

—telegraph, telephone and radio

◆

This history began with the January 1, 1932, issue of RADIO ENGINEERING. The items are numbered chronologically, beginning at 2000 B.C., and will be continued down to modern times. The history records important dates, discoveries, inventions, necrology and statistics, with numerous contemporary chronological tie-in references to events in associated scientific development. The material was compiled by Donald McNicol.

◆

Part XVIII

1884 (Continued)

- (678) An experimental telephone line is built between Boston and New York.
- (679) The Postal Telegraph-Cable Company opens an office in Washington, D. C.
- (680) A printing telegraph system embodying features of older systems, and with improvements, is introduced by Buckingham and Van Sise and used on American lines.
- (681) The Western Union cable office at 16-18 Broad Street, New York, is opened to the public.
- (682) Theodore Du Moncel dies. (Born in France 1821.)
- (683) At the Toronto, Canada, Exhibition an electric locomotive is used to haul a train of cars. The contact conductor is placed underground.
- (684) The general employment is begun by American telegraph companies of hard drawn copper wire.
- (685) The Chesapeake and Potomac Telephone Company lays an underground conduit one and one-half miles in Washington, D. C. Six cables containing 500 wires are enclosed in an 18 x 18 inch trough under the sidewalk.
- (686) The Commercial Cable Company lays two transatlantic cables between Ireland and Nova Scotia.
- (687) The Commercial Cable Company opens (December 24) the first submarine cable brought directly into a seaport.
- (688) S. J. M. Baer presents a paper before the American Institute of Electrical Engineers, New York, on the subject "Telegraphing Without Wires."
- (689) Law Telegraph System, New York, acquired by Metropolitan Telegraph and Telephone Co.
- 1885 (690) Edison, assisted by Gilliland, Phelps and Smith develops a system of telegraphing by induction between moving trains and stationary offices.
- (691) The International Telegraph Convention is held in Berlin, Germany.
- (692) A telegraphers' fast-sending tournament is held, April 5, in the offices of the United Press, New York.
- (693) Pneumatic tubes are installed underground extending from 23rd St. and Fifth Avenue to Broadway and Dey Street, New York, by the Western Union Telegraph Company.
- (694) Richards, of the Bell Telephone Company, Boston, introduces the headband telephone receiver.
- (695) Telephone tests are made between New York and Chicago over the lines of the Postal Telegraph-Cable Company, February 6, by means of Webster Gillette telephone instruments.
- (696) H. Ward Leonard installs an electric light dimmer in McVickers Theatre, Chicago.
- (697) Steel-clad copper wire for telegraph purposes is introduced in the United States.
- (698) The Dominion Telephone Company, and the Toronto Telephone Manufacturing Company, in Canada, conduct a legal fight to prevent the American Bell Telephone Company from doing business in Canada.
- (699) The United Lines Telegraph Company acquires control of the property of the Bankers and Merchants Telegraph Company. (Shortly afterward the United Lines Company is taken over by the Postal Telegraph-Cable Company.)
- (700) Daniel S. Robeson, a stockholder in the American Rapid Telegraph Company, in behalf of himself and other stockholders brings suit in the Circuit Court asking for an accounting. In the Court proceedings Roscoe Conkling appears for the company, and Col. Robert G. Ingersoll for Mr. Robeson.
- (701) John W. Mackay employs Albert B. Chandler to manage his telegraph and cable enterprises.
- (702) The National Printing Telegraph Company is organized with a capital of \$1,000,000 to commercialize the printer system of Samuel V. Essick. Abner McKinley and George H. Fearon are among the incorporators.
- (703) The North American Telegraph Company is organized, at St. Paul, Minn., with a capital of \$1,000,000.
- (704) The American Printing Telegraph Company is organized, with a capital of \$200,000, by John C. Cruikshank, L. K. McKinney, J. S. Silver, Frederick Reed and W. P. Arnold. The purpose of the company is to acquire ownership of patents.
- (705) The Southern Telegraph Company with 4,000 miles of line is taken over by the Western Union Telegraph Company.
- (706) The Government institutes suit at Columbus, Ohio, to determine the validity of Bell's telephone patent.
- (707) An electric railway two miles in length is placed in operation between Baltimore and Hampden, Maryland, September 1. Installation made by H. A. Foster for Daft Electrical Company.
- (708) The Serial Building Loan and Savings Institution is organized, in New York.
- (709) The National Electric Light Association is organized in Chicago with eighty-seven members. (February.)
- (710) The American Telephone and Telegraph Company organized, taking over various Bell telephone companies.
- (711) P. B. Delany's synchronous multiplex telegraph system is tried out on lines of the Baltimore and Ohio Telegraph Company.
- (712) Fleeming Jenkin dies. (Born in England 1833.)
- (713) John Muirhead dies. (Born in England 1807.)
- (714) The Atlantic Telegraph Company builds a line from Boston, Mass., to Portland, Maine. (Two years later this line was leased by the Baltimore and Ohio Telegraph Company, later passing to the Western Union Telegraph Company, the lease to expire February 1, 1907.)
- (715) A two mile section of the Ninth Avenue elevated railroad, New York, is equipped with cars operated by Daft electric motors. George R. Metcalfe was identified with this work.
- (716) Van Rysselberghe, of Belgium, comes to the United States to introduce his system of simultaneous telegraphy and telephony.
- (717) Carty and Barrett, in the United States, improve telephone transmission by transposing the two wires of line circuits.
- (718) George B. Scott improves the Wright and Longstreet stock ticker instrument.
- (719) The Graphophone is invented by S. Tainter and A. G. Bell.
- (720) William Stanley, Jr., of Great Barrington, Mass., begins the development of alternating current generators for electric light and power.

(To be continued)

SYNTHANE

Laminated Bakelite

**Dependable Uniformity in Electrical
and Mechanical Properties**

**DIELECTRIC STRENGTH · LOW WATER ABSORPTION
STRUCTURAL STRENGTH · LOW SURFACE LEAKAGE
CLEAN PUNCHING · MACHINEABILITY
IMPACT STRENGTH · APPEARANCE**



OFFICES IN PRINCIPAL CITIES

Sheets, Tubes, Rods, Fabricated Parts
Silent, Stabilized Gear Material

S.S. WHITE PRODUCTS *in* RADIO

• **FLEXIBLE SHAFTS** •
for REMOTE CONTROLS

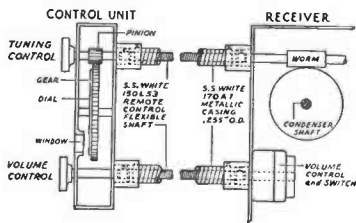

Full data on this application will be supplied to anyone interested, on request. We are also ready to assist in working out any specific application of the flexible shaft for remote control. *Simply send us the essential details.*

S. S. W. Flexible Shaft No. 150L53 was developed specifically for remote control of radio receivers. It has minimum torsional deflection, and this deflection is equal for either direction of rotation. When shaft is geared as shown, deflection is virtually eliminated.
S.S.W. Metallic Casing No. 170A1, with small (.255") outside diameter, was also specially designed for remote control applications.

• **MOLDED RESISTORS** •
for ELECTRONIC EQUIPMENT

Comparative tests and actual service have proved the *superiority of S.S.W. Resistors in permanence of resistance value, noiseless operation and mechanical strength.*
Today, these Resistors are extensively used in commercial radio receivers, transmitters, condenser microphone amplifiers, resistance coupled amplifiers, public address system amplifiers, traffic signal controls, sensitive electronic hospital and laboratory apparatus, etc.

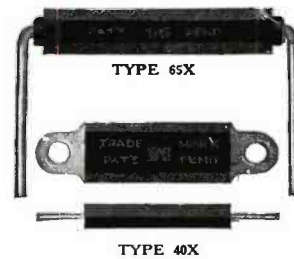

Above are shown, actual size, two of the many types of S.S.W. Molded Resistors. They range from $\frac{1}{4}$ to 2 watts, with resistances from 1,000 ohms to 1,000,000 megohms. *Write for the Descriptive Circular.*

The S.S. WHITE Dental Mfg. Co., INDUSTRIAL DIVISION

152-4 WEST 42nd STREET, NEW YORK, N. Y.

NEWS OF THE INDUSTRY

SYNTHANE REPRESENTATIVES

Clyde L. Way has recently been appointed by Synthane Corporation, Oaks, Pa., manufacturers of Synthane laminated bakelite, to represent them in the St. Louis territory. His offices are at 608 Security Building, St. Louis, Mo.

Mr. Way is an established manufacturers' representative in this territory and in representing Synthane Corporation he is in a position to be of immediate service to manufacturers for Synthane sheets, rods, tubes, fabricated parts and gear material.

Synthane Corporation also has offices and representatives in New York, Philadelphia, Chicago, Cleveland, Boston, Detroit, Minneapolis, Atlanta, New Orleans, Dallas, San Francisco, Dayton, Pittsburgh and Kansas City.

OILED TUBING AND SLEEVING

William Brand & Company, 268 Fourth Avenue, New York, have issued a new catalog describing a high grade line of sheet and tubular insulation used by manufacturers of radio apparatus.

Standard Turbo oil tubing is manufactured from closely braided cotton yarn, fabric being thoroughly impregnated (not dipped) with a high quality of insulating varnish and then baked. This dipping and baking process is repeated many times until a wall of the required thickness is obtained, and the smooth surface both on the inside and outside wall of the tubing results. Turbo oil tubing, magneto grade is further characterized by flexibility with a higher dielectric strength. It is slow burning and will not ignite from solder iron.

IRC MOVES OFFICES

General offices of the International Resistance Company have been combined with the IRC engineering department in spacious new quarters at 2100 Arch street, Philadelphia, Pa. Previously the offices were located at 2006 Chestnut street. Besides supplying much needed space for expansion of both offices and engineering department, the new arrangement makes for even greater efficiency in the designing and promotion of IRC Metallized, Power and Precision Wire Wound Resistors and other radio service products in which the company specializes.

President Ernest Searing and Sales Manager Harry Kalker extend a cordial invitation to jobbers and manufacturers to drop in for a visit at the new quarters whenever they are in the Quaker City.

TRANSMITTER EQUIPMENT

Radio transmitting equipment, including transformers, inductances and power amplifiers, is being marketed by the Radio Service Supply Company, 271 Central Avenue, Newark, N. J.

EDGAR S. REIDEL

Effective May 15, Mr. Reidel became general sales manager for sales through jobber-dealer channels, of the Raytheon Production Company. Mr. Reidel previously was with the Reichmann Company, Utah Radio Products Co., and Grigsby-Grunow.



RCA TO NEW HEADQUARTERS

The Radio Corporation of America announces the removal of its headquarters offices in New York, from 570 Lexington Ave. to the RCA Building, No. 30 Rockefeller Plaza.

GILBY WIRE COMPANY

The Gilby Wire Company, 150 Riverside, Newark, N. J., with offices in Chicago, Ill., and in Paris, France, announces the promotion of Sidney A. Woods to general sales manager of the company, and of Herbert J. Hahn to chief engineer and metallurgist. Mr. Hahn has had seven years' experience in the laboratories of the company.

WORLD'S FAIR MEDAL

It is interesting to note that the official commemorative medal of the Century of Progress International Exposition was made from dies engraved by and struck by the Crowe Name Plate and Manufacturing Company, Chicago.

The Crowe Company manufactures a complete line of escutcheons, dials and name plates for radio receivers.

IRC BULLETIN

The engineering staff of the International Resistance Company have prepared a booklet which should be of interest to every radio engineer. The booklet contains interesting records of performance in such resistor factors as permanence, overload and humidity characteristics, voltage coefficient and low level of noise. Radio engineers may obtain a copy of this booklet by addressing the International Resistance Company, 2100 Arch St., Philadelphia, Pa.

RECTOX BATTERY CHARGERS

The Westinghouse Rectox Battery Charger is completely described and illustrated in a recent four-page publication issued by the Westinghouse Electric and Manufacturing Company. The construction, application, and operation of the charger are explained in the leaflet pointing out the distinctive features and advantages of this type of dry, non-chemical, metallic oxide rectifier. Copies of the leaflet may be obtained from the nearest district office or direct from the advertising department at East Pittsburgh, Penna.

WIRE CLOTH

The Audubon Wire Cloth Company, Inc., has been acquired by the Manganese Steel Forge Company, Philadelphia, Penn. The company has set up a specialty department for the manufacture of radio parts using wire cloth. At the present time a double shift staff is at work to keep up with orders.

ALVIN ZINKAN

Effective May 15, Mr. Zinkan became assistant general sales manager for the Raytheon Production Company. For ten years Mr. Zinkan was associated with the National Carbon Company.



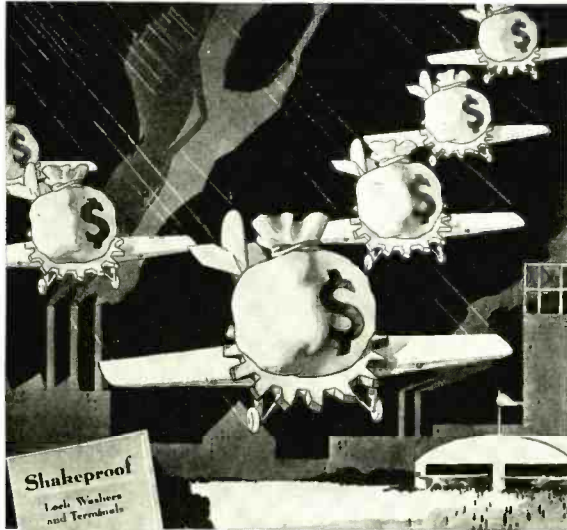

"VIBRATION CONTROL".

brings

EXTRA PROFITS

Send today for your free copy of this complete Shakeproof Catalog. Explains thoroughly the many advantages that Shakeproof offers—also shows new patented Shakeproof products.

● The damaging action of Vibration which has been robbing industry of sizeable profits can now be controlled. Shakeproof Lock Washers have made this possible and every thinking manufacturer should give serious consideration to the advantages of this superior locking method. Vibration always begins its attack at connecting points, but, when every nut and screw is turned down tight on a Shakeproof Lock Washer, no harm can be done. The result is improved performance—more satisfied customers, and that always means increased sales and extra profits. Write today for free testing samples and our new complete catalog!

SHAKEPROOF
Lock Washer Company

(Division of Illinois Tool Works)

2509 N. Keeler Ave.

Chicago, Ill.



Only **Centralab**
can improve
Centralab

and Centralab has done it!

LIKE gilding the Lily
this NEW Centralab Volume Control brings refinements that a few years ago were impossible and unnecessary.

New circuits, new tubes and the new *miniature* sets demand new SMALL Volume Controls.



Centralab has given the industry a new Control that maintains its leadership, in smooth, silent, dependable performance with the smaller size receiver now so much in demand.

Production will soon be "underway." Write for specifications and samples.

CENTRAL RADIO LABORATORIES, *Milwaukee*

Centralab

NEW DEVELOPMENTS OF THE MONTH

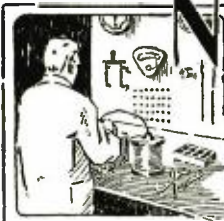

REPLACEMENT SUPPRESSOR KITS

Continental Carbon Inc., 13900 Lorain Ave., Cleveland, Ohio, is now supplying replacement auto-radio ignition suppressor kits for 4, 6, and 8 cylinder cars, complete—including one Continental "certified" suppressor for each spark plug lead and for the high tension lead from the ignition coil to the distributor. Each suppressor is individually packed in cellophane, assuring clean, perfect condition when installed in the motor.

A metal-enclosed generator filter condenser, especially designed to withstand heat and vibration, is also included in each



kit. The makers recommend that the generator condenser be replaced at the same time as the suppressors, since condenser failure is very frequently due to the high operating temperature and severe vibration.

The resistance element of Continental suppressors is pressure molded and fired at high temperatures to assure permanence of resisting value, eliminating trouble from low resistances that fail to suppress noise and high resistances that reduce ignition system interference.

SCREEN GRID CAP

The F. R. Zierick Mfg. Co., 68-72 E. 131st Street, New York, N. Y., has developed a new screen-grid cap, No. 154, to be used with the new shields and tubes, and is especially adapted to the compact midget radios.

These caps not only reinforce the wire, but can be put on from either the top or side of the tube. The caps are made of brass and are hot tinned, to insure easy soldering.

This company is equipped to give prompt deliveries and low prices. Samples will be gladly submitted.

NEEDLES FOR RECORDS

Meyer Koulisch Company, 64 Fulton St., New York City, announces a line of recording points including diamond point and sapphire for celluloid discs. The company also handles shavers and other accessories for record making.

NEW CEMENT FINDS MANY RADIO USES

A practical liquid porcelain cement is the latest development of Henry L. Crowley & Company, ceramic engineers and manufacturers of West Orange, N. J. It is available in three consistencies: a cement paste for application with trowel or similar tool; a dipping cement suitable for dipping, spraying or brushing, and a dry powder ready to be mixed with water to the desired consistency. The cement paste is widely employed in radio production assembly for holding small parts in place, and for filling holes and cracks as a sealing compound. The dipping cement is employed for coating electrical resistors and radio coil forms, as well as for general adhesive purposes.

Setting in a short time without the application of heat, liquid porcelain is proof against oil, acids, gases and heat up to 2,000 deg. F. It can be made waterproof. It is an excellent electrical insulator. It is being made available in small cans for experimenter and repair shop use, and in large cans and steel drums for bulk users.

SPEAKER DIAPHRAGMS

The improved performance of modern radio loudspeakers is in part a result of betterment in diaphragms. Cone speakers of molded seamless paper fiber made up in one piece with voice coil collar and flexing ring integral with cone are the most recent product of the United Pressed Products Co., 407 South Aberdeen St., Chicago, Ill. The company is in a position to take prompt care of export orders.

THE MOTOVOX

The Motometer Gauge and Equipment Company, Toledo, Ohio, is marketing the Tetradyne automotive radio receiver. The



set uses five tubes in the chassis and one in the power supply.

RELAYS

The Signal Engineering and Mfg., Company, 140 West 14th St., New York, announce a new bulletin R-22 showing the Company's line of relays. The C-7 type



relay, illustrated herewith is adaptable for various radio circuits. Copies of this important booklet will be sent upon request.

NEW MOLDING MATERIAL

A new product has been developed by Bakelite Corporation that offers many interesting possibilities. It is called Impact Molding Material because of its superior mechanical characteristics. It is a tough substance with several times the shock resistance of ordinary molding material, the kind that is used for switch plates and the like. In many respects it is similar to the Bakelite laminated products well known to the public in the form of radio panels, table tops, etc. It differs, however, in that it can be molded and, therefore, is adaptable to a wide range of shapes.

PHOTOCELLS

The General Scientific Corporation, Lumatron Vacuum Products Division, 4829 Kedzie St., Chicago, Ills., announces a modern line of Lumatron photoelectric cells. These cells are of various types and sizes. The company has issued a descriptive booklet which may be procured upon request.

JENSEN LOUSPEAKERS

The Jensen Radio Manufacturing Company, Chicago, Ill., announce the marketing of a remote controlled auxiliary loudspeaker for connection to midget receivers. The speaker is mounted in a neat cabinet, provided with a pair of connecting leads.

TYPE 50 FREQUENCY CONVERTER



A multiple Frequency Generator of many uses

Type 50 Frequency Converter, COMPLETE
WITH CRYSTAL, CRYSTAL HOLDER,
TUBES AND FILAMENT
SUPPLY **\$135**

Descriptive literature on request.

Write for Bulletin No. R26

1. Will check any U. S. Broadcast transmitter and monitor and permit accurate setting to frequency.
2. May be checked against WWV or any other reliable standard of frequency.
3. Will hold closely on frequency for a long period of time without any adjustment.
4. Rapid compensation for drift.
5. Produces frequencies from ten kilocycles to several thousand kilocycles.
6. Crystal controlled.

International Broadcasting Equipment Co.

4508 RAVENSWOOD AVENUE
CHICAGO, U. S. A.

Cable Address "Fortinco" All Codes



BOMBARDING

Equipment capable of meeting all demands.

Fixtures and bombarding coils for special applications.

High Frequency Furnaces

Designers and builders of high frequency converters for over 20 years.

LEPEL

HIGH FREQUENCY LAB., INC.

39 WEST. 60th STREET NEW YORK

a Water Resistant MOLDING COMPOUND

RESINOX



Developed especially to provide the cosmetic industry with molded packages and caps which will not swell or crack when in contact with water, Resinox W-R is proving itself useful to many other industries.

Electrical parts molded with Resinox W-R have the strength and beauty characteristic of all Resinox products plus an extraordinary resistance to moisture.

● *Keep in touch with Resinox developments*

Specify Resinox MOLDING RESINS · MOLDING COMPOUNDS · LAMINATING VARNISHES

RESINOX CORPORATION

A subsidiary of Commercial Solvents Corporation and Corn Products Refining Co.

230 PARK AVENUE

NEW YORK CITY

A NEW TUBE SHIELD

After having specialized in the design and production of parts for radio tubes, Goat Radio Tube Parts, Inc., 314 Dean Street, Brooklyn, New York, are now addressing themselves to the manufacture of complete sets, with a new design of tube shield.

As shown in the accompanying illustrations, it differs from the conventional cylindrical type of tube shield in that it conforms to the shape of the dome type of bulb, which is why it has been christened the "glove-fitting" tube shield.

The illustrations will also make it clear

that the shield is made in two halves, and these so formed that a clamping ring may be slid up on it from the lower end and snapped into the groove provided therefor, thus holding the two halves together, snugly hugging the bulb.

It is said that this tube shield costs less than the cylindrical type, partly in itself, and partly because it is so easily grounded by means of a simple clip fastened to the chassis.

The manufacturers also point out that this tube shield is of logical design and therefore looks better.



FLARED BAFFLE SOUND PROJECTORS

The Racon Electric Co., 52 East 19th St., New York, is marketing a flared baffle sound projector equipped with mounting block for cone speaker and self-supporting frame. The use of a baffle projector of this type increases the efficiency of the cone speaker and improves the sound distribution, extending the frequency response, particularly in the low frequency range.

NEW ACROTONE AUTO AMPLIFIER

A powerful, self-contained, triple push-pull, three-stage auto amplifier, known as the Acratone model 770, has been developed by Federated Purchaser, Inc., 23-25 Park Place, New York City. This amplifier is designed to operate directly from any six-volt storage battery.

The new Acratone amplifier uses two '36 tubes in push-pull in the first stage coupled in resistance bridge arrangement to two '37 tubes in push-pull, transformer coupled to two '42 pentodes in push-pull in the output stage.

A motor-generator is incorporated within the unit, which supplies 320 volts at 100 milliamperes.

The undistorted power output of the Acratone auto amplifier is 7 watts. It can be used to drive from two to six speakers to normal maximum speaker undistorted output and it has ample voltage amplification to work directly from a double-button carbon mike, without additional pre-stages or booster amplifiers.

The new 770 Amplifier is equipped with

a built-in microphone and phonograph matching transformer which matches any single or double button microphone. Connections are provided for pickups of different impedances, varying all the way from low impedance pickups to pickups of 5,000 ohms impedance.

R-F. OSCILLATOR

A radio frequency oscillator, Model 301, useful for general laboratory measurement and test work, 10 to 2,000 meters, is announced by The Egert Engineering Co., 179 Greenwich St., New York.

SCREENS FOR CATHODE RAY TUBES

A new screen material developed by the Allen B. DuMont Laboratories for use on cathode ray tubes enables a spot intensity five times as brilliant as any screen previously used. This is particularly valuable for photographic recording. A unique feature of this screen is the ability to retain for well over a minute any wave or figure applied to it when used in a darkened room or hood. This feature, however, in no way affects the use of the tube for ordinary oscillograph use or for photographic recording, because of the large difference between the spot intensity and the afterglow. Any of the various styles of cathode ray tubes made by this laboratory can be supplied with this new screen at slight additional cost.

RADIO TUBE PROGRESS

RAYTHEON 2A3

THE Raytheon 2A3 power output tube is of the indirectly heated type, using three heaters, three cathodes and three grids within a formed plate structure common to all three sets of elements—each cathode tied to the midpoint of each heater. This tube is interchangeable with other standard makes of 2A3 tubes. The construction is a departure from the ladder-like filament of other makes, making for ruggedness, freedom from shorts and from a-c. hum.

THE 12-A-5

This is a power pentode amplifier tube, announced by Raytheon Production Corporation. The tube employs two cathodes with three heater connections to three base prongs which may be operated in parallel at 6.3 volts in automobile sets, or in series at 12.6 volts for use in 110 volt, a-c., d-c. receivers.

ARCTURUS 75, 77 AND 78

The Arcturus Company's type 75 tube is a heater type duplex-diode triode. The high-mu triode has a heater voltage of 6.3 volts, 0.3 ampere, maximum plate volts 250.

The plate current delivered by one diode unit operating as a half-wave rectifier depends upon the load resistance. Due to the high plate impedance (91,000 ohms) of the triode unit resistance coupling is recommended for the output circuit. With a 250 volt plate supply a suitable value of resistance is 0.1 megohm.

The 77 is a uni-potential cathode triple grid detector amplifier operating on 6.3 volts. The 78 is a cathode triple-grid super-control amplifier operating on 6.3 volts.

RCA-CUNNINGHAM 79 AND 12Z3

The 6.3 volt RCA-79, Cunningham C-79 are reported to be satisfactory for Class B operation with 250 volts plate. With this plate voltage and a 37 tube used in the driver stage, the 79 in Class B gives a power output of about 8 watts.

The 12Z3 RCA-Cunningham tube is of the high vacuum type employing a 12.6 volt heater cathode. This tube has good regulation characteristics, which facilitate its use in universal receivers.

HALF WAVE RECTIFIER TUBE

RCA-Cunningham announce a half-wave rectifier tube designated as RCA radiotron 1-V, Cunningham C-1-V. This is a high vacuum tube employing a 6.3 volt heater cathode, and is stated to be particularly suitable for the universal and automobile radio receivers. The maximum plate volts are 350 and the d-c. output 50 milliamperes.

TUBE CHARACTERISTICS

The Arcturus Radio Tube Company, Newark, N. J., has issued a technical chart giving the electrical and physical characteristics of about sixty different radio receiving tubes. Copies may be procured upon request.

ACME WIRE PRODUCTS

All Acme Products are made to recognized commercial standards, including those of National Electric Mfrs. Assn., Radio Mfrs. Assn. and American Soc. for Testing Materials...

COILS
MAGNET WIRE WOUND

AERIAL WIRE
STRANDED AND SOLID

MAGNET WIRE
ALL INSULATIONS

PARVOLT CONDENSERS
FILTER AND BY-PASS—ALSO FOR
POWER FACTOR CORRECTION

VARNISHED INSULATIONS
CAMBRIC, SILK, PAPER, TAPE

THE ACME WIRE CO., NEW HAVEN, CONN.
*For over 25 years, suppliers to the largest
radio and electrical manufacturers*

CONDENSER FOIL

TIN LEAD ALUMINUM
FOR CONDENSERS

44 YEARS MANUFACTURING
EXPERIENCE IS YOUR
GUARANTEE OF QUALITY
MATERIAL AND
SATISFACTORY SERVICE

STANDARD WIDTHS IN STOCK
FOR PROMPT SHIPMENT

The Johnston Tin Foil & Metal Co.

DEPT. RC 10
6016-6160 S. BROADWAY
ST. LOUIS, MO.
EST. 1889

EASTERN OFFICE
AND WAREHOUSE
1224 HALSEY ST.
BROOKLYN, N. Y.

F. W. FLAD
Representative
Tel. JE 1549



NEW!
UNIVERSAL MODEL "E"
Condenser Type Microphone

Amazing quality at a sensationally low price. 90° Swivel Head with Automatic Barometric Adjustment—2-Stage Amplifier—Non-Microphonic Tubes—Solid Bar Grating Diaphragm Protection—Polished Aluminum and Chrome Plated—At dealers' net cost of \$54.00, this is by all odds the greatest value in microphone history.

UNIVERSAL MICROPHONE CO., Ltd.
424 Warren Lane Inglewood, Calif., U. S. A.

LAMINATIONS

for Audio & Power Transformers
SPECIALIZED METHODS—YEARS OF EXPERIENCE
Wide Variety of Stock Standard Sizes
Dimension and Price Sheets on request
We Also Make
PERMANENT MAGNETS—DIES—TOOLS—
METAL STAMPINGS
Facilities for prompt service

Thomas & Skinner
Steel Products Co. 1100 to 1120
E. Twenty-Third St.
INDIANAPOLIS, IND.

Introducing **POWERACK**

RADIO CHASSIS, INC. OF NEW YORK CITY

110 Volts A.C. in Your Car
Voltage Constant at All Speeds
at 10 m.p.h. or 50 voltage is 110 a.c.

POWERACK is mounted at the head of the motor in such a way that it takes its driving force from the same source which turns the charging generator and the motor fan. There is absolutely no drain from the car or truck storage battery. POWERACK fits all cars or trucks. Mounting is simple and there is no upkeep, since there are no wear or tear parts.

MODEL 21
50-WATT OUTPUT
LIST PRICE
\$32.50

MODEL 23
100 WATT OUTPUT
LIST PRICE
\$39.50

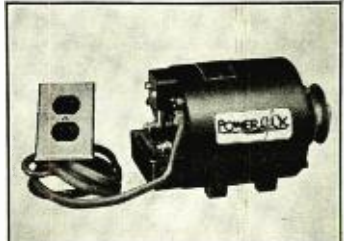

POWERACK is made in wattage output up to 500 watts.
*Write for detailed information on varied uses and
dealer's proposition.*

Powerack Television & Radio Corp.
Subsidiary of Radio Chassis, Inc.
112 W. 18TH STREET NEW YORK, N. Y.

NOW!

\$100

PROTECTION GUARANTY
To your INSTRUMENTS when
protected by

LITTELFUSES



LITTELFUSES will positively protect your meters, radios, tube testers, etc. Stock sizes 1/100, 1/32, 1/16, 1/8, 1/4, 3/8, 1/2, 3/4, 1, 1 1/2, 2 amps. capacities.

LITTELFUSES are also made in 1,000-5,000- and 10,000-volt ranges.

Write for New Cat. No. 5
complete details

LITTELFUSE LABS., 1778 Wilson Ave., Chicago, Ill.

**ON MY WAY TO
NEW YORK AND
THE PICCADILLY**



... best hotel I know!
Near everything, just
200 feet from Broad-
way. Modern, hospita-
ble, and comfortable.
Like the Manager,
like the rates—\$2.50
single, \$3.50 double,
for a room with bath!

**THE HOTEL -
PICCADILLY**

45th St. • W. of Broadway • New York
WILLIAM MADLUNG, Mng. Dir.

... for Tubes • Resistors • Relays ...

Carbonized Nickel
Selvage Mesh
(patented)

Filament Wire
Grid Wire



**RESISTANCE
WIRE**

Nickel Chrome
Copper Nickel
Nickel Wire
and Ribbon

GILBY WIRE
MEANS
MAXIMUM PRODUCTION
With MINIMUM SHRINKAGE

GILBY WIRE COMPANY
150 Riverside Ave., Newark, N. J.

**PHOTOELECTRIC CELL
APPLICATIONS**

By R. C. Walker and T. M. C. Lance.
Practical ways in which photoelectric cells are actually used, with only such theoretical discussion as is essential to the explanation. \$2.50

**ACOUSTICAL
ENGINEERING**

By W. West. The science of sound applied to various engineering problems and devices. \$4.50

**TALKING
PICTURES** 2nd Ed.

By Bernard Brown. Theory, installation and operation of principal systems clearly explained. \$3.00

TELEVISION

To-Day and To-Morrow. 3rd Ed.
By Sidney A. Moseley and H. J. Barton Chapple. Foreword by John L. Baird. Pioneer endeavor and current achievement, with a view of the possibilities of development. \$2.50

PITMAN PUBLISHING CORPORATION
2 West 45th Street New York, N. Y.

WANTED:

Experienced radio men to sell a line of nationally-advertised test equipment direct to radio servicemen. Write care of this publication, Box 61, Radio Engineering, 19 East 47th Street, New York City.

INDEX TO ADVERTISERS

<p>A</p> <p>Acme Wire Co., The..... 29</p> <p>Allen-Bradley Co..... 6</p> <p>American Electro Metal Corp..... 31</p> <p>C</p> <p>Callite Products Div..... 31</p> <p>Central Radio Labs..... 25</p> <p>Chicago Telephone Supply Co..... 5</p> <p>Clarostat Mfg. Co.....Third Cover</p> <p>D</p> <p>Daven Co., The..... 32</p> <p>Dumont Labs., Allan B..... 31</p> <p>E</p> <p>Erie Resistor Corp..... 27</p> <p>F</p> <p>Frost, Herbert H., Sales Div..... 5</p> <p>G</p> <p>Gilby Wire Co..... 30</p>	<p>I</p> <p>Int'l. Broadcasting Equip. Co..... 27</p> <p>International Resistor Co..... 1</p> <p>J</p> <p>Johnston Tin Foil & Metal Co..... 29</p> <p>L</p> <p>Lenel High Frequency Labs..... 27</p> <p>Littelfuse Labs..... 30</p> <p>M</p> <p>Morrill & Morrill..... 31</p> <p>P</p> <p>Parker-Kalon Corp..... 3</p> <p>Pitman Publishing Corp..... 30</p> <p>Powerack Television & Radio Corp. 29</p> <p>R</p> <p>Racon Electric Co., Inc.....Back Cover</p> <p>Resinox Corporation..... 27</p>	<p>S</p> <p>Scientific Radio Service..... 31</p> <p>Shakeproof Lock Washer Co..... 25</p> <p>Swedish Iron & Steel Corp. Second Cover</p> <p>Synthane Corp..... 23</p> <p>T</p> <p>Thomas & Skinner Steel Products Co..... 20</p> <p>U</p> <p>United Pressed Products Co..... 31</p> <p>Universal Microphone Co., Ltd..... 29</p> <p>W</p> <p>White Dental Mfg. Co., The. S. S. 23</p> <p>Z</p> <p>Zierick Mfg. Co., F. R..... 31</p> <p>Zophar Mills, Inc..... 31</p>
---	--	--

ELMET Molywire

Exact in Diameters
Lengths to 1500 Meters
Moderate Prices
Elongation Uniform
Tested for Grids

BEST BY EVERY TEST

ELMET stands for the best there is in MOLYWIRE. *Use the Best. It Saves You Money.* Furnished on Bakelite Spools or Iron Bands up to 1500 Meters.

IRON BANDS
 BAKELITE SPOOLS

Write for Information and Prices to Box R-6

AMERICAN ELECTRO METAL CORP. ♦ LEWISTON, MAINE



RELIABILITY

SIEMENS & HALSKE HIGH VOLTAGE CONDENSERS

USED WHERE
QUALITY COUNTS

MORRILL & MORRILL
 30 CHURCH STREET NEW YORK CITY

Sole U.S.A. Distributors of the
Siemens & Halske
Condensers and Resistors

For Your Experimental Department

A tube of 500 assorted lugs and terminals — hot tinned for easy soldering.

We are also prepared to handle production stampings.

Price \$1.00

Write Us for Quotations



F. R. ZIERICK MFG. COMPANY
 70 E. 131st ST., NEW YORK CITY

PIEZO ELECTRIC CRYSTALS

"Superior by Comparison"

Why You Should Use Scientific Radio Service Crystals

- 1 Since 1925, we have been specializing in producing Piezo Electric Crystals exclusively.
- 2 Since 1925, Scientific Radio Service Crystals have stood the test and are recognized the world over for their Dependability, Output and Accuracy of Frequency.
- 3 Since 1925, owners of Broadcast and Commercial Short Wave stations have found that no chances can be taken in getting the cheaper grade of crystals and that invariably they call on Scientific Radio Service for the Best.
- 4 Since 1925, we could be depended upon to make Prompt Shipments. This coupled with a crystal Second to None considering Output and Accuracy of Frequency has earned during these years a reputation which we jealously guard. Therefore, Get the Best.

Price list sent upon request

SCIENTIFIC RADIO SERVICE
 "The Crystal Specialists"

124 Jackson Avenue, University Park, Hyattsville, Maryland

- WAXES
- COMPOUNDS
- VARNISHES

For Insulation of Condensers

Transformers, coils, power packs, pot heads, sockets, wiring devices, wet and dry batteries, etc. Also WAX SATURATORS for braided wire and tape. WAXES for radio parts. Compounds made to your own specifications if you prefer.

● ZOPHAR MILLS, INC.

FOUNDED 1846
 Court, Lorraine and Creamer Sts., Brooklyn, N. Y.
 Agents: Ralph B. Clark, 2007 Calumet Ave., Toledo, Ohio
 H. A. B. Sneve Co., San Francisco, Seattle, New Orleans

TUNGSTEN and MOLYBDENUM ROD, SHEET and WIRE

for Cathodes, Supports and Welds

- Special Tungsten Filament Coils
- Tungsten Contacts for Auto "B" Eliminators and Special Purposes

CALLITE PRODUCTS DIV.
 UN'ON CITY NEW JERSEY

SPEAKER CONE DIAPHRAGMS

MOULDED SEAMLESS PAPER FIBER
 USED BY THE LEADERS IN RADIO INDUSTRY
 OLDEST CONE MANUFACTURER—LOWEST IN PRICE

UNITED PRESSED PRODUCTS CO.
 PRESSED AND MOULDED SHAPES IN PAPER AND FABRIC
 407 SOUTH ABERDEEN ST. CHICAGO, ILLINOIS

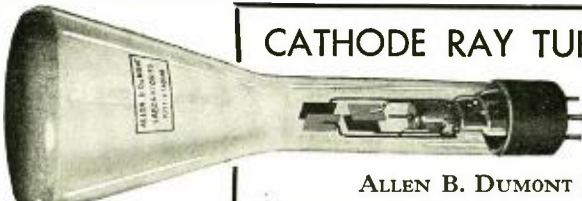

CATHODE RAY TUBES for ALL STANDARD UNITS

Rugged, brilliant, low-priced DuMont cathode ray tubes are available in all standard sizes. DuMont adapters also allow their interchangeable use in other standard cathode ray equipment.

Technical data on cathode ray tubes and equipment sent on request.

ALLEN B. DUMONT LABORATORIES
 Upper Montclair, N. J.

• DAVEN •

POWER LEVEL INDICATORS

HIGH ACCURACY

±0.1 db or better

HIGH SENSITIVITY

Flat frequency characteristics up to 50,000 cycles. Twenty steps of attenuation.



- Type A-185 Cabinet Mounting —10 db to +46 db
- Type B-185—Panel Mounting —10 db to +46 db
- Type C-185 Cabinet Mounting —20 db to +36 db
- Type D-185 Panel Mounting —20 db to +36 db

• SUPER DAVOHN •

WIRE WOUND
PRECISION
RESISTANCES

Accurate—Non-Inductive Low Distributed Capacity. Impregnated under Vacuum. Range 0.1 to 5,000,000 ohms.

Resistance Wire Depending Upon Your Requirements.

Set Analyzers are Improved With the Use of Super Davohn Wire Wound Resistances

SUPER DAVOHN'S
ARE
DEPENDABLE



(ACTUAL SIZE)
Type B-20
A few of the popular types.

Literature of our complete line of Mixers, H, T & L Pads, Potentiometers, Filament Rheostats and Decade Resistance Boxes sent free upon request.

THE DAVEN COMPANY

158-160 SUMMIT STREET, NEWARK, NEW JERSEY

THE Group Subscription Plan for RADIO ENGINEERING enables a group of engineers or department heads to subscribe at one-half the usual yearly rate.

The regular individual rate is \$2.00 a year. In groups of 4 or more, the subscription rate is \$1.00 a year. (In Canada and foreign countries \$2.00.)

The engineering departments of hundreds of manufacturers in the radio and allied industries have used this Group Plan for years, in renewing their subscriptions to RADIO ENGINEERING.

Each subscriber should print his name and address clearly and state his occupation—whether an executive, engineer, department head, plant superintendent, or foreman, etc.

Remember this Group Plan when Your Subscription Expires

(Radio Engineering)

Bryan Davis Publishing Co, Inc.
19 East 47th Street
New York, N. Y.

Los Angeles

Chicago

St. Louis

CLAROSTAT
TRADE MARK REG. U. S. PAT. OFF.

Replacement Line Ballasts Are Solving Many Problems!



To obtain maximum efficiency and low cost of operation with modern radio sets, the voltage of the power source should be kept to within 5% of the voltage rating for which the set is designed.

A rated 110-115 volt line oftimes will vary from as low as 90 volts to as high as 140 volts in different sections and at different times during the day, due to differences in distance from the power house, varying loads and poor regulation due to overloaded branch circuits.

Clarostat Line Ballasts will maintain the normal voltage across the primary of the power transformers of sets within the allowable limits for efficient operation in spite of line voltage fluctuations over a range of from 95 to 135 volts. They may be easily installed at reasonable cost.

The main feature of Clarostat Products is their positive reliability. Resistance elements are wound with the highest grade of resistance wire obtainable, on carefully selected and tested Bakelite strips. Tapers are obtained by the time-tried and tested method of proper spacing, shape of winding form and the use of wires of the proper resistance characteristics. Exhaustive accelerated life tests prove conclusively that our units stand up for years under hard service without appreciable wear or change in characteristics. Thus, they cost less than cheap units that are not dependable.

Free Engineering Service

Clarostat engineers have made special, intensive studies of the needs of various circuits which require the use of wire wound or graphite element volume and tone controls, and the design of units of special resistance and taper characteristics to best suit such requirements.

—Let Us Know Your Control Problems!—

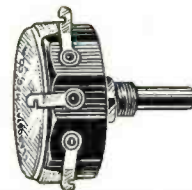

"P58" Control Without Switch



"MH" Circular Hum-Dinger

CLAROSTAT MFG. CO. I N C.



285 NORTH 6th STREET

BROOKLYN, N. Y.



THE FINEST SOUND TRUCKS USE RACON REPRODUCERS

In practically every state in the Union you will find efficient, high-quality sound trucks making money with their complement of Racon Reproducers. Discriminating public address specialists have learned that Racon quality and reliability means dependable performance "under fire", sure profits and increased rental contracts.



Racon manufactures the most complete line of horns on the market today. A few types are illustrated: The Triple-Connector assembly, ideal for small cars and all-around service. The Radial Horn, the most remarkable and economical projector ever made. The Six-Foot Flat Bell Trumpet, especially good for roof-top mounting and concealment.

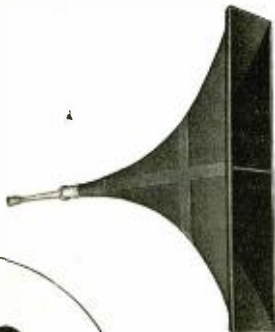

To match these outstanding Racon Horns there is a complete line of type B units, heavy duty, high power drivers that will withstand the most severe service demands.



You will find it practical and profitable to incorporate Racon Stormproof Guaranteed Reproducers in your sound car set-up.

RACON Horns and Units are Covered by U. S. Patents Nos. 1,507,711; 1,501,032; 1,577,270; 73,217; 73,218; 1,722,448; 1,711,514; 1,781,489; 1,832,608; 1,834,327; 1,835,739; 1,845,210; 1,878,360; 1,888,442.

RACON ELECTRIC CO. INC.

52 East 19th Street, New York City
London, England Toronto, Canada